

Los Angeles County Flood Control District

DESIGN MANUAL

HYDRAULIC

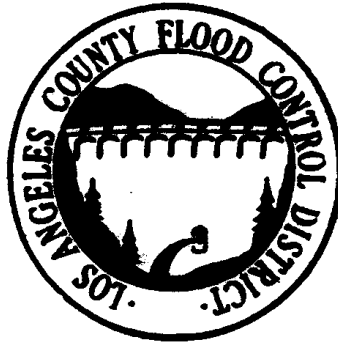

MARCH 1982

2250 Alcazar Street
Los Angeles, California

P.O. Box 2418, Terminal Annex
Los Angeles, California 90051

TABLE OF CONTENTS

<u>Description</u>	<u>Page No.</u>
Section A - Design Hydrology	
A-1 General Hydrology Criteria	A-1
A-2 Design Q	A-1
Section B - Criteria for Hydraulic Design: Closed Conduits	
B-1 General Hydraulic Criteria	B-1
B-2 Water Surface Profile Calculations	B-1
2.1 Determination of Controlling Water Surface Elevation	B-1
2.2 Instructions for Hydraulic Calculations	B-3
2.3 Head Losses	B-4
B-3 Special Cases	B-8
3.1 Transition from Large to Small Conduit	B-8
3.2 Branching of Flow in Pipe: Head Loss	B-9
B-4 Design Requirements for Maintenance and Access	B-9
4.1 Manholes	B-9
4.2 Pressure Manholes	B-11
4.3 Special Manholes	B-11
4.4 Deep Manholes	B-11
4.5 Inlets into Main Line Drains	B-11
4.6 Minimum Pipe Size	B-11
4.7 Minimum Slope	B-12
4.8 Inlet Structures	B-12
4.9 Outlet Structures	B-12
4.10 Protection Barriers	B-13
4.11 Debris Barriers	B-13
4.12 Debris Basins	B-13
B-5 Other Closed Conduit Criteria	B-14
5.1 Angle of Confluence	B-14
5.2 Flapgates	B-14
5.3 No-Joint Cast-in-Place Concrete Pipe	B-14
5.4 Rubber-Gasketed Pipe	B-15
5.5 Asbestos Cement Pipe	B-15
5.6 Non-Reinforced Concrete Pipe	B-15
5.7 Corrugated Steel Pipe	B-15
5.8 Tunnel Sections	B-16
B-6 Computer Programs	B-16
Section C - Criteria for Hydraulic Design: Open Channels	
C-1 General Hydraulic Criteria	C-1
C-2 Water Surface Profile Calculations	C-1
2.1 General	C-1
2.2 Determination of Controlling Water Surface Elevation	C-2
2.3 Direction of Calculation	C-3
2.4 Head Losses	C-3
2.5 Side-Channel Spillway Inlets	C-4
2.6 Transitions	C-5
2.7 Piers	C-7

<u>Description</u>	<u>Page No.</u>
C-3 Curving Alignments	C-10
3.1 Superelevation	C-10
3.2 Easement Curves	C-13
C-4 Freeboard	C-15
C-5 Roll Waves	C-15
C-6 Other Criteria	C-16
6.1 Composite Linings	C-16
6.2 Maximum Sidewall Slopes	C-16
6.3 Unlined Channels	C-17
6.4 Revetted Channels	C-17
 Section D - Catch Basins	
D-1 Design Q	D-1
D-2 Required Data and Calculations	D-2
2.1 Street Flow Carrying Capacity	D-2
2.2 Catch Basin Size and Type	D-2
2.3 Connector Pipe and "V" Depth Calculation	D-2
D-3 Other Criteria	D-6
3.1 General	D-6
3.2 Catch Basins	D-7
3.3 Local Depressions	D-9
3.4 Connector Pipe	D-9
3.5 Inlet No. 1	D-10
Notes and Assumptions Applicable to Catch Basin Charts	D-11
 Section E - Pump Station Design	 E-1
 Section F - Miscellaneous	
F-1 Hydraulic Jump	F-1
1.1 Location	F-1
1.2 Length	F-1
F-2 Trashrack Head Loss	F-2
F-3 Side Channel Weirs	F-2
F-4 Pier Extensions	F-3
The City of Los Angeles Thompson Equation	F-5
Hydraulic Analysis of Junctions	F-6
Example Problems	
Determination of Water Surface Profile	F-16
Design of Straight Contraction	F-22
Maximum Depth for Channel With Break in Slope	F-23
Side Channel Spillway Design	F-25
Catch Basin Hydrology	F-28
Levee Criteria	F-29

I N D E X O F C H A R T S

<u>Chart No.</u>	<u>Description</u>	<u>Page No.</u>
B-01	Hydraulic Grade Line Calculation Sheet	G-1
B-10	Bend Losses	G-2
B-11	Factors for Closed Conduits Flowing Full	G-3
B-20	Location of Transition	G-4
C-01	water Surface Computation Sheet	G-5
C-02	Side Channel Spillway Inlet Calculation Sheet	G-6
C-10	Bridge Pier Losses	G-7
C-11	Approximate Bridge Pier Losses	G-8
C-12	Approximate Bridge Pier Losses	G-9
C-20	Converging Transition-Supercritical Flow	G-10
C-30	Roll Waves	G-11
C-31	Roll waves	G-12
C-32	Roll waves	G-13
D-01	Street Flow - Local Street	G-14
D-02	Street Flow - Secondary Highway	G-15
D-03	Street Flow - Secondary Highway	G-16
D-04	Street Flow - Major Highway	G-17
D-05	Street Flow - Major Highway	G-18
D-06	Street Flow - Major Highway	G-19
D-07	Street Flow - Major Highway	G-20
D-08	Street Flow - Major Highway	G-21
D-09	Street Capacity Charts	G-22
D-10A	Side Opening Catch Basin Capacities	G-23
D-10B	Side Opening Catch Basin Capacities	G-24
D-10C	Side Opening Catch Basin Capacities	G-25
D-10D	Side Opening Catch Basin Capacities	G-26
D-13	Grating Capacities	G-27
D-14	Grating Capacities	G-28
D-15	Grating Capacities	G-29
D-20	Catch Basin Capacities - C.B. No. 8	G-30
D-21	Catch Basin Capacities - C.B. No. 8	G-31
D-22	Catch Basin Capacities - C.B. No. 8	G-32
D-26	Catch Basin Capacities - Sump Condition	G-33
D-30	Design of Connector Pipes	G-34
D-31	Catch Basin V-Depth	G-35
D-40	Catch Basin Calculation Sheet	G-36
F-02	Partially-Filled Circular Sections	G-37
F-03	Factors for Partially-Filled Circular Sections	G-38
F-04	Values of Manning's n	G-39
F-05	Values of Manning's n for C.S.P.	G-40
F-06	Corrugated Steel Pipe with Paved Invert	G-41



SECTION A

DESIGN HYDROLOGY

Section ADESIGN HYDROLOGYA-1 General Hydrology Criteria

The following criteria will be used as a basis of hydrological design:

- a. In those situations where the proposed drain forms the upstream terminus of the drainage system and will be connected to an outlet of restricted capacity the design Q shall be compatible with the outlet condition. In those situations where the proposed drain connects to a restricted outlet drain which is part of a system that the District or other agency intends to upgrade with future relief the criteria stated below shall govern.
- b. For drains to be located in natural existing watercourses or which will serve as outlets for sump areas, a storm frequency of 50 years shall apply. A sump is defined as a low area which prevents the free passage of water with consequent flooding of streets or private property.
- c. For drains where the above criteria are not applicable, a storm frequency of not less than 10 years shall apply.

For uniformity, the hydrology will be based upon standards and methods of computation used by the Los Angeles County Flood Control District and the District's basic data (Coefficient Curves, Intensity Duration Curves, Isohyetal Map and Soil Maps). Please refer to the District's Hydrology Manual for methods and data.

A-2 Design Q

The hydrology will be furnished by the District's Hydraulic Division for District projects. Typical data will include a sketch map showing drainage boundaries and design data sheets indicating the reach Q's, frequency, peak subarea Q's and type of Q, if other than "clear Q". Subareas result from the initial breakdown by the District of the total drainage area and are designated by numbered circles on the drainage maps furnished by the District.

Discrepancies in drainage area boundaries with those furnished by the District should be discussed with the District's Design Division. If any problems remain, the conflicts should be resolved with the District's Hydraulic Division.

A-2 Design Q continued.

If, during the design of a project, it is determined that the reach Q's furnished by the District should be broken down by subreaches between the interception points assumed in the main line hydrology, then the Q's for the subreaches (Q_{SUBR}) shall be determined as follows:

$$\Delta Q_{SUBR} = \frac{A}{A_T} \Delta Q_R$$

where ΔQ_{SUBR} = Change in Q for the subreach in question. (To determine the subreach Q, add the ΔQ_{SUBR} to the design Q at the upstream end of the subreach.)

A = Area in acres tributary to the intermediate interception point. Does not include areas tributary to interception points upstream.

A_T = Total area, in acres, of the appropriate subarea.

ΔQ_R = Difference in Q between the reach in question and the reach upstream.

It is intended that streets crossing the alignment be considered intermediate interception points and that the reach of main line between such points be considered a subreach.

If a drain is to be designed for the restricted outlet capacity, the Design Q's shall be determined as follows:

$$Q_{DES} = \frac{Q_{CAP}}{Q_{RO}} Q_R$$

where Q_{CAP} = Capacity of the outlet

Q_{RO} = Reach Q at the outlet (from the hydrology)

Q_R = Reach Q in question (from the hydrology)

Exceptions to the above policies must be approved by the District.

A-2 Design Q continued.

If the designer discovers a discrepancy in subarea acreage and if the discrepancy is 10 percent or less or 3 acres or less than the total subarea acreage, then subarea Q's and main line reach Q's can be adjusted in lieu of requesting the hydrology to be retabled. Use the following procedure to adjust Q's:

$$Y \text{ (yield/acre)} = \frac{Q \text{ (original)}}{A \text{ (original)}}$$

$$Q \text{ (adjusted)} = Y \cdot A \text{ (corrected)}$$

Both subarea Q's and main line reach Q's can be adjusted with this procedure; however, it should be noted that the yield/acre may differ for the subarea Q and main line Q.

On projects where hydrology has been furnished by the District, the designer is requested to submit a copy of the original hydrology data sheet furnished by the District marked up with the corrected subarea acreage, subarea Q's, and main line Q's. This will alert the District's reviewer that changes have been made by the designer and he can readily check the magnitude of the change.



SECTION B

CRITERIA FOR HYDRAULIC DESIGN:
CLOSED CONDUITS



Section BCRITERIA FOR HYDRAULIC DESIGN
CLOSED CONDUITSB-1 General Hydraulic Criteria

Closed conduit sections (pipe, box, or arch sections) shall be designed as flowing full, whenever possible, and may be allowed to flow under pressure except when the following conditions exist:

- a. In some areas of high debris potential, there is a possibility of stoppage occurring in drains. In situations where debris may be expected, the District's Hydraulic Division shall be consulted for a determination of the appropriate bulking factor.
- b. In certain situations open channel sections upstream of the proposed closed conduit may be adversely affected by back pressure.

If the proposed conduit is to be designed for pressure conditions, the hydraulic grade line shall be positioned sufficiently below the surface of the street to efficiently intercept catch basin flows. However, in those reaches where no surface flow will be intercepted, a hydraulic grade line which encroaches on or is slightly higher than the ground or street surface will be acceptable. Reference is made to subsection B-4.2 for requirements for pressure manholes.

B-2 Water Surface Profile CalculationsB-2.1 Determination of Controlling Water Surface Elevation

A conduit to be designed for pressure conditions may discharge into one of the following:

- a. A body of water such as a reservoir or the ocean.
- b. A natural watercourse or ravine.
- c. An open channel, either improved or unimproved.
- d. Another closed conduit.

B-2.1 Determination of Controlling Water Surface Elevation continued.

The controlling water surface elevation at the point of discharge is commonly referred to as the control and, for pressure flow, is generally located at the downstream end of the conduit. If flow becomes unsealed, the control may be at the first gradebreak upstream of the point where unsealing occurs or, under certain conditions, may be farther upstream.

Two general types of controls are possible for a conduit on a mild slope, which is a physical requirement for pressure flow in discharging conduits.

- a. Control elevation above the soffit elevation. In such situations the control shall conform to the following criteria:
 - (1) In the case of a conduit discharging into a reservoir, the control shall be the reservoir water surface elevation.
 - (2) In the case of a conduit discharging into an open channel, the control shall be the design water surface elevation of the channel.
 - (3) In the case of a conduit discharging into another conduit, the control shall be the highest hydraulic grade line elevation of the outlet conduit immediately upstream or downstream of the confluence.
 - (4) In the case of a conduit discharging into the ocean, the control shall be approved by the District prior to preparation of hydraulic calculations.
- b. Control elevation at or below the soffit elevation. The control shall be the soffit elevation at the point of discharge. This condition may occur in any one of the four situations described on page B-1.

Hydraulic grade line elevations to be used as controls for projects in many cases may be obtained from the District's Design Division. Exceptions to the above policy must be approved by the District.

B-2.2 Instructions for Hydraulic Calculations

Most procedures for calculating hydraulic grade line profiles are based on the Bernoulli equation. This equation can be expressed as follows:

$$\frac{V_1^2}{2g} + D_1 + S_0 L = \frac{V_2^2}{2g} + D_2 + S_f L + h_{\text{minor}}$$

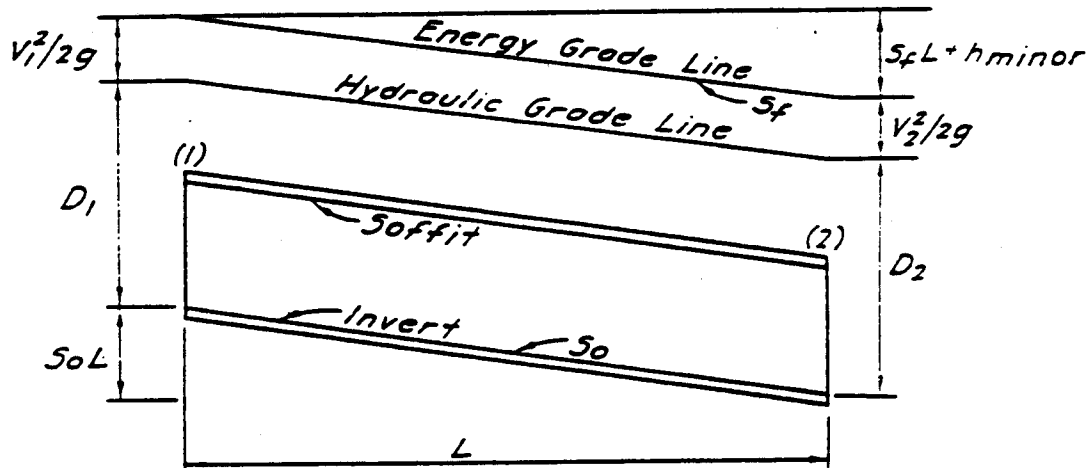

- in which
- D = Vertical distance from invert to H.G.L.
 - S_0 = Invert slope
 - L = Horizontal projected length of conduit
 - S_f = Average friction slope between Sections 1 and 2
 - V = Average velocity (Q/A)
 - h_{minor} = Minor head losses

Minor losses have been included in the Bernoulli equation because of their importance in calculating hydraulic grade line profiles and are assumed to be uniformly distributed in the above figure.

B-2.2 Instructions for Hydraulic Calculations continued.

When specific energy (E) is substituted for the quantity $V^2/2g + D$ in the above equation and the result rearranged,

$$L = \frac{E_2 - E_1}{S_0 - S_f}$$

The above is a simplification of a more complex equation and is convenient for locating the approximate point where pressure flow may become unsealed.

The format in use at the District for calculating hydraulic grade line profiles is shown on Chart No. B-01. For use in expediting such calculations a computer program is available. (See page B-16.)

B-2.3 Head LossesB-2.3.1 Friction Loss

Friction losses for closed conduits carrying storm water, including pump station discharge lines, shall be calculated from the Manning equation or a derivation thereof. The Manning equation is commonly expressed as follows:

$$Q = \frac{1.486}{n} AR^{2/3} S_f^{1/2}$$

in which Q = Discharge, in c.f.s.
 n = Roughness coefficient
 A = Area of water normal to flow in ft.²
 R = Hydraulic radius
 S_f = Friction slope

When rearranged into a more useful form,

$$S_f = \left[\frac{Qn}{1.486 AR^{2/3}} \right]^2 = \left[\frac{Q}{K} \right]^2$$

in which

Hyd. Man.

$$K = \frac{1.486 AR^{2/3}}{n}$$

B-2.3.1 Friction Loss continued.

The loss of head due to friction throughout the length of reach (L) is calculated by:

$$h_f = S_f L = \left[\frac{Q}{K} \right]^2 L$$

The value of K is dependent upon only two factors: the geometrical shape of the flow cross section as expressed by the quantity $AR^{2/3}$, and the roughness coefficient (n). The values of n shown in Chart No. F-04 & F-05 shall be used.

Values of K corresponding to an n value of .013 for reinforced concrete pipe and equivalent reinforced concrete box sizes are shown on Chart No. F-01.

B-2.3.2 Transition Loss

Transition losses shall be calculated from the equations shown below. These equations are applicable when no change in Q occurs and where the horizontal angle of divergence or convergence (θ) between two sections does not exceed $5^\circ 45'$.

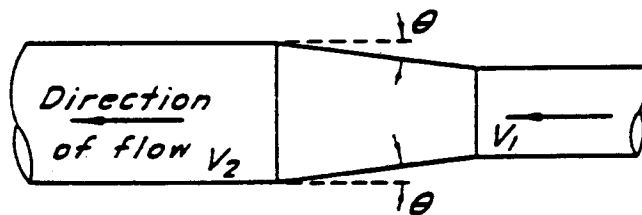

For velocities which increase in the direction of flow ($V_2 > V_1$),

$$h_f = .1 \left[\frac{V_2^2}{2g} - \frac{V_1^2}{2g} \right]$$

For velocities which decrease in the direction of flow ($V_2 < V_1$),

$$h_f = .2 \left[\frac{V_1^2}{2g} - \frac{V_2^2}{2g} \right]$$

B-2.3.2 Transition Loss continued.

Deviations from the above criteria must be approved by the District. When such situations occur, the angle of divergence or convergence (θ) may be greater than $5^{\circ}45'$. However, when θ is increased beyond 10° , the above equations will give results for h_t that are too small and the values for h_t derived from the preceding formulas should be increased by multiplying h_t by the following:

- For $10^{\circ} < \theta < 15^{\circ}$ Multiply h_t by 2
- For $15^{\circ} < \theta < 20^{\circ}$ Multiply h_t by 3
- For $20^{\circ} < \theta < 25^{\circ}$ Multiply h_t by 4
- For $\theta > 25^{\circ}$ Multiply h_t by 5

B-2.3.3 Junction Loss

In general, junction losses shall be calculated by equating pressure plus momentum through the confluences under consideration. This can be done by using either the District's P + M method or the City of Los Angeles' Thompson equation, both of which are shown in Section F. Both methods are applicable in all cases for pressure flow and will give the same results.

For the special case of pressure flow with $A_1 = A_2$ and friction neglected,

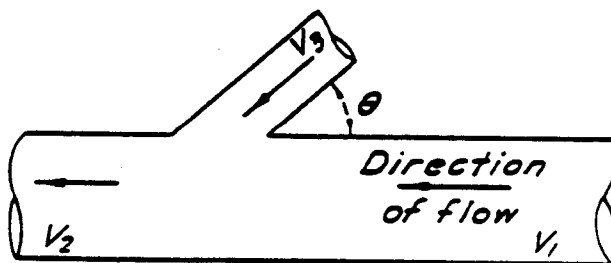

$$h_j = \frac{V_2^2}{2g} - \frac{V_1^2}{2g} - \frac{2A_3}{A_2} \cdot \frac{V_3^2}{2g} \cdot \cos \theta$$

B-2.3.4 Manhole Loss

Manhole losses shall be calculated from the equation shown below and shall be used only for District Manhole Nos. 1 and 2. Where a change in pipe size and/or change in Q occurs, no additional head loss need be calculated for the manhole. It is considered to be included in the transition and or junction loss.

$$h_{m.h.} = .05 \left[\frac{V^2}{2g} \right]$$

B-2.3.5 Bend Loss

Bend losses shall be calculated from the following equations:

$$h_b = K_b \left[\frac{V^2}{2g} \right]$$

in which

$$K_b = 0.20 \sqrt{\frac{\Delta}{90^\circ}}$$

where Δ = Central angle of bend in degrees

K_b may be evaluated graphically from Chart No. B-10 for values of Δ not exceeding 90 degrees.

Bend losses should be included for all closed conduits, those flowing partially full as well as those flowing full.

B-2.3.6 Angle Point Loss

Angle point losses shall be calculated from the following equation:

$$h_{a. pt.} = .0033 \theta \left[\frac{V^2}{2g} \right]$$

in which θ = Deflection angle in degrees, not to exceed 6° without prior approval from the District.

B-3 Special Cases

B-3.1 Transition From Large to Small Conduit

As a general rule, storm drains shall be designed with sizes increasing in the downstream direction. However, when studies indicate it may be advisable to decrease the size of a downstream section, the conduit may be decreased in size in accordance with the following limitations:

- a. For slopes of .0025 (.25 percent) or less, only conduits 75 inches and greater may be decreased. A reduction is limited to a maximum of 6 inches.
- b. For slopes of more than .0025, only conduits 33 inches and greater may be decreased. Each reduction is limited to a maximum of 3 inches for pipe 48 inches in diameter or smaller, and to a maximum of 6 inches for pipe larger than 48 inches in diameter. Reductions exceeding the above criteria must have District approval.

In any case the reduction in size must result in a more economical system.

Where conduits are to be decreased in size due to a change in grade, the criteria for locating the transition shall be as shown on Chart No. B-20. A design that doesn't follow this criteria must have District approval.

B-3.2 Branching of Flow in Pipe - Head Loss

The following equation may be used to determine the loss of head in cases where it may be necessary to split or branch the flow into another drain.

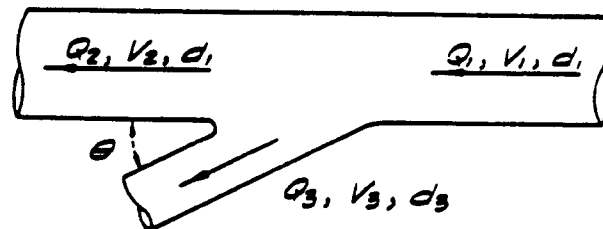

$$h_{br.} = C \frac{V_1^2}{2g}$$

Values for the coefficient C may be obtained from the table below and apply only to straight reaches of pipe of constant diameter. For angles of divergence (θ) and ratios of Q_3/Q_1 other than those shown, values of C may be interpolated.

Divergence Angle- θ	$\frac{Q_3}{Q_1} = 0.9$	$\frac{Q_3}{Q_1} = 0.5$	$\frac{Q_3}{Q_1} = 0.7$
90°	$C = 0.76$	$C = 0.74$	$C = 0.80$
60°	$C = 0.59$	$C = 0.54$	$C = 0.52$
45°	$C = 0.35$	$C = 0.32$	$C = 0.30$

B-4 Design Requirements for Maintenance and Access

B-4.1 Manholes

B-4.1.1 Spacing

a. Conduit diameter 30 inches or smaller:

Manholes shall be spaced at intervals of approximately **300 feet**. Where the proposed conduit is less than 30 inches in diameter and the horizontal alignment has numerous bends or angle points, the manhole spacing shall be reduced to approximately 200 feet.

B-4.1.1 Spacing continued.

- b. Conduit diameter larger than 30 inches but smaller than 45 inches:

Manholes shall be spaced at intervals of approximately 400 feet.

- c. Conduit diameter 45 inches or larger:

Manholes shall be spaced at intervals of approximately 500 feet.

The spacing requirements shown above apply regardless of design velocities. Deviations from the above criteria shall be subject to District approval.

B-4.1.2 Location

Manholes should not be located in street intersections, especially when one or more streets are heavily traveled.

In situations where the proposed conduit is to be aligned both in easement and in street right of way, manholes should be located in street right of way, wherever possible.

Manholes shall be located as close to changes in grade as feasible when the following conditions exist:

- a. When the upstream conduit has a steeper slope than the downstream conduit and the change in grade is greater than 10 percent, sediment tends to deposit at the point where the change in grade occurs.
- b. When transitioning to a smaller downstream conduit due to an abruptly steeper slope downstream, debris tends to accumulate at the point of transition. Please refer to Section B-3.1 above and to Chart No. B-20.

B-4.1.3 Design

When the design flow in a pipe flowing full has a velocity of 20 f.p.s. or greater, or is supercritical in a partially full pipe, the total horizontal angle of divergence or convergence between the walls of the manhole and its center line shall not exceed $5^{\circ}45'$.

B-4.2 Pressure Manholes

A pressure manhole shaft and a pressure frame and cover shall be installed in a pipe or box storm drain whenever the design water surface is more than 1 foot above the top of the manhole cover. In cases where the flow in the storm drain could exceed the design Q and the water surface for the higher Q could produce a water surface over 1 foot above the top of the manhole cover, a pressure manhole shaft and a pressure frame and cover shall be installed.

B-4.3 Special Manholes

Special 36-inch diameter manholes or vehicular access structures shall be provided when required by the District. The need for access structures will be determined by the District during its review of the plans.

B-4.4 Deep Manholes

A manhole shaft safety ledge shall be provided in all instances when the manhole shaft is 20 feet or greater in depth. Installation shall be in accordance with District Standard Drawing No. 2-D430.

B-4.5 Inlets into Main Line Drains

Lateral pipe entering a main line pipe storm drain generally shall be connected radially. Lateral pipe entering a main line box structure shall conform to the following:

- a. Lateral pipe 24 inches or less in diameter shall be no more than five feet above the invert.
- b. Lateral pipe 27 inches or larger in diameter shall be no more than 18 inches above the invert, with the exception that catch basin connector pipe less than 50 feet in length may be no more than five feet above the invert.

Exceptions to the above requirements may be permitted where it can be shown that the cost of bringing laterals into a main line box conduit in conformance with the above requirements would be excessive.

B-4.6 Minimum Pipe Size

The minimum diameter of main line conduit shall be 24 inches, unless otherwise approved by the District.

In cases where the conduit may carry significant amounts of debris, the minimum diameter of main line conduit shall be 48 inches. The minimum diameter main line conduit conveying flows from a debris basin shall be 36 inches. In situations where debris may be expected, the District's Hydraulic Division shall be consulted to determine the applicability of debris criteria.

Tunnel sections shall have a minimum equivalent diameter of 60 inches.

Hyd. Man.

B-4.7 Minimum Slope

The minimum slope for main line conduit shall be .001 (.10 percent), unless otherwise approved by the District.

For debris carrying storm drains, the minimum drain slope shall be .05 (5 percent). In cases where it is not feasible to design the drain for .05 (5 percent) the District may approve a slope of .03 (3 percent).

B-4.8 Inlet Structures

An inlet structure shall be provided for storm drains located in natural channels. The structure should generally consist of a headwall, wingwalls to protect the adjacent banks from erosion, and a paved inlet apron. The apron slope should be limited to a maximum of 2:1. Wall heights should conform to the height of the water upstream of the inlet, and be adequate to protect both the fill over the drain and the embankments. Headwall and wingwall fencing and the District's Standard protection barrier or trash rack shall be provided to prevent public entry. The trash rack should be used for inlets 48-inches (diameter or width) and smaller. For inlets larger than 48-inches a special designed trash rack may be required.

If debris is prevalent, barriers consisting of vertical 3-inch or 4-inch diameter steel pipe spaced at 1/3 the main line diameter or width to a maximum of 30 inches on centers should be embedded in concrete immediately upstream of the inlet apron.

B-4.9 Outlet Structures

- a. Where a storm drain discharges into the ocean, the designer should check with the District's Design Division Engineering Analysis Group for up-to-date criteria as to location and type of structure to be used.
- b. When a storm drain outlets into a natural channel, an outlet structure shall be provided which prevents erosion and property damage. Velocity of flow at the outlet should agree as closely as possible with the existing channel velocity. Fencing and a protection barrier shall be provided.
 - (1) When the discharge velocity is low, or subcritical, the outlet structure shall consist of a headwall, wingwalls, and an apron. The apron may consist of a concrete slab, or grouted rock.
 - (2) When the discharge velocity is high, or supercritical, the designer shall, in addition, consider bank protection in the vicinity of the outlet and an energy dissipator structure. The District will furnish, upon request, drawings of various types of energy dissipators used on past projects.

B-4.10 Protection Barriers and Trash Racks

A protection barrier is a means of preventing people from entering storm drains. Protection barriers may consist of large, heavy breakaway gates, single horizontal bars across catch basin openings, or chain link fencing around an inlet or an exposed outlet. Catch basin protection bars are detailed and specified as to their use in the District's Standard Drawings Manual.

Protection barriers shall be provided wherever necessary to prevent unauthorized access to storm drains. The District's Standard Trash Rack is normally used for inlets 48-inches (diameter or width) or smaller.

In some cases the protection barrier and trash rack may be one of the types detailed in the District's Standard Drawings Manual. In other cases they may be a special design to be shown on the construction drawings. It shall be the designer's responsibility to provide a protection barrier or trash rack, or both, appropriate to each situation.

B-4.11 Debris Barriers

A debris barrier or deflector is a means of preventing large debris, such as tree limbs, logs, boulders and refuse, from entering a storm drain and possibly plugging the conduit. The debris barrier should have openings wide enough to allow as much small debris as possible to pass through and yet narrow enough to protect the smallest conduit in the system downstream of the barrier. One type that has been used effectively by the District in the past is the debris rack. This type of debris barrier is usually formed by a line of posts, such as steel pipe filled with concrete or steel rails, across the line of flow to the inlet. An example of this type would be the debris barrier designed for Hidden Hills Project No. 4101, Drawing No. 364-4101-D5.1. It shall be the designer's responsibility to provide a debris barrier or deflector appropriate to the situation.

B-4.12 Debris Basins

Debris basins, check dams and similar structures are a means of preventing mud, boulders and debris held in suspension and carried along by storm runoff from depositing in storm drains. Debris basins constructed upstream of storm drain conduits, usually in canyons, trap such material before it reaches the conduit. Debris basins must be cleaned out on a regular basis, however, if they are to continue to function effectively. Refer to the District's Debris Dams and Basins Design Manual regarding the criteria to be used in designing these structures.

B-5 Other Closed Conduit Criteria

B-5.1 Angle of Confluence Angle of Confluence

In general, the angle of confluence between main line and lateral shall not exceed 45 degrees and, as an additional requirement, shall not exceed 30 degrees under any of the following conditions:

- a. Where the flow (Q) in the proposed lateral exceeds 10 percent of the main line flow.
- b. Where the velocity of flow in the proposed lateral is 20 f.p.s. or greater.
- c. Where the size of the proposed lateral is 60 inches or greater.
- d. Where hydraulic calculations indicate excessive head losses may occur in the main line due to the confluence.

Connector pipe may be joined to main line pipe at angles greater than 45 degrees up to a maximum of 90 degrees provided none of the above conditions exist. If, in any specific situation, one or more of the above conditions does apply, the angle of confluence for connector pipes shall not exceed 30 degrees. Connections shall not be made to main line pipe which may create conditions of adverse flow in the connector pipes.

The above requirements may be waived only if calculations are submitted to the District showing that the use of a confluence angle larger than 30 degrees will not unduly increase head losses in the main line.

B-5.2 Flapgates

A flapgate shall be installed in all laterals outletting into a main line storm drain whenever the water surface level of the main line is higher than the surrounding area drained by the lateral.

The flapgate must be set back from the main line drain so that it will open freely and not interfere with the main line flow. A function structure shall be constructed for this purpose in accordance with District Standard Drawing No. 2-D192.

B-5.3 No-Joint Cast-in-Place Concrete Pipe

Refer to the District's Structural Design Manual criteria regarding no-joint cast-in-place concrete pipe. The Manning's value for cast-in-place concrete pipe is .014. The n value for reinforced concrete pipe is .013.

B-5.4 Rubber-Gasketed Pipe

For criteria regarding the use of rubber-gasketed pipe, refer to the District's Structural Design Manual.

B-5.5 Asbestos Cement Pipe

The criteria for determining the use of asbestos cement pipe shall be as follows:

- a. Asbestos cement pipe may be used for main line and lateral construction provided that:
 - (1) The pipe diameter is 42 inches or less.
 - (2) The velocity does not exceed 5 feet per second under abrasive conditions. Abrasive conditions are considered to exist where the tributary drainage areas include undeveloped land that may contribute significant amounts of erosive materials to the drain, such as slate, hard shales and granitic materials, large cobbles and boulders, etc.
 - (3) The velocity does not exceed 20 feet per second.
- b. Asbestos cement pipe may be used for catch basin connector pipe 42 inches or less in diameter except where significant amounts of erosive materials may enter the catch basins during storms.

Refer to the District's Structural Design Manual for instructions regarding D-load requirements for asbestos cement pipe.

Refer to the District's Project Preparation Instruction Manual for instructions regarding the general notes to be placed on bond issue drawings pertaining to the use of asbestos cement pipe.

B-5.6 Non-Reinforced Concrete Pipe

The same velocity and abrasion restrictions that apply to asbestos cement pipe shall apply to non-reinforced concrete pipe.

B-5.7 Corrugated Steel Pipe

In locations where corrugated steel pipe will be a permanent installation the invert shall be paved with concrete (see chart F06). Manning's n values for corrugated steel pipe are shown on chart F05.

B-5.8 Tunnel Sections

Make every effort in the hydraulic design to maintain the same cross section throughout a tunnel reach, as this will generally result in the most economical construction.

B-6 Computer Programs

A District Water Surface Pressure Gradient-Hydraulic Analysis computer program is available (Program F0515P). If a computer program other than the District's is used, the District's hydraulic grade line calculation sheet (Page G-1) or water surface computation sheet (Page G-5) shall be completely filled out and submitted.



SECTION C

CRITERIA FOR HYDRAULIC DESIGN:
OPEN CHANNELS



Section CCRITERIA FOR HYDRAULIC DESIGNOPEN CHANNELSC-1 General Hydraulic Criteria

In general, all open channels should be designed with the tops of the walls or levees at or below the adjacent ground to allow interception of surface flows. If it is unavoidable to construct the channel without creating a pocket, a means of draining the pocket must be indicated on the drawings.

In making preliminary layouts for the routing of proposed channels, it is desirable to avoid sharp curvatures, reversed curvatures, and closely-spaced series of curves. If this is unavoidable, the design considerations in Section C-3 shall be followed to reduce superelevations and to eliminate initial and compounded wave disturbances.

It is generally desirable to design a channel for a Froude number of just under 2.0. In the area within the Los Angeles County Flood Control District, however, this is not always possible because of steep terrain. If the Froude number exceeds 2.0, any small disturbance to the water surface is amplified in the course of time and the flow tends to proceed as a series of "roll waves". Reference is made to Section C-3.4 for criteria when designing a channel with a Froude number that exceeds 2.0.

In the design of a channel, if the depth is found to be at or near critical depth [Froude No. ($F = v/\sqrt{gD}$) = 1.0] for any significant length of reach, the shape or slope of the channel should be altered to secure a stable flow condition.

C-2 Water Surface Profile CalculationsC-2.1 General

Water surface profile calculations shall be calculated using the standard step method. Confluences and bridge piers are analyzed using pressure and momentum theory. See Appendix for forms used in hand calculations. For use in expediting such calculations, a computer program (F0515P) is available. (See page B-16)

C-2 Water Surface Profile Calculations continued.

C-2.2 Determination of Controlling Water Surface Elevation

The following are generally control points for the calculation of the water surface profile:

1. Where the channel slope changes from mild to steep or critical, the depth at the grade break is critical depth.
2. Where the channel slope changes from critical to steep, the depth at the grade break is critical depth.
3. Where a discharging or outletting channel or conduit is on a mild slope, the water surface is generally controlled by the outlet (see Section B-2.1).
4. When a channel on a steep slope discharges into a facility that has a water surface depth greater than the normal depth of the channel, calculate pressure plus momentum for normal depth and compare it to the pressure plus momentum for the water surface depth at the outlet according to the equation, $P_n + M_n \sim P_o + M_o$.
 - a. If $P_n + M_n > P_o + M_o$, this indicates upstream control with a hydraulic jump at the outlet.

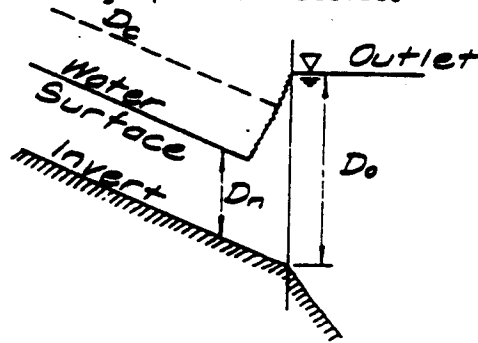

- b. If $P_n + M_n < P_o + M_o$, this indicates outlet control with a hydraulic jump probably occurring upstream.

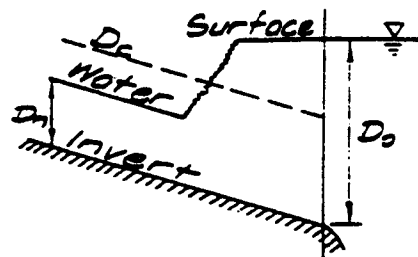

C-2 Water Surface Profile Calculations continued.

- c. Where the water surface of the outlet is below the water surface in the channel or conduit, control will be upstream and the outflow will have the form of a hydraulic drop.

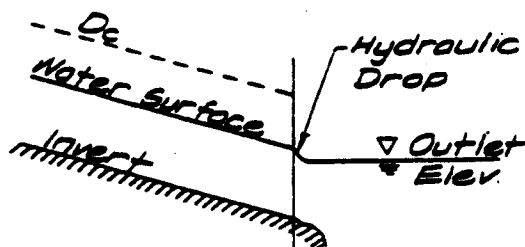

When there is a series of control points, the one located farthest upstream shall be used as a starting point for water surface calculation.

C-2.3 Direction of Calculation

Calculations shall proceed upstream when the depth of flow is greater than critical depth and shall proceed downstream when the depth of flow is less than critical depth.

C-2.4 Head Losses

C-2.4.1 Friction Loss

Friction losses for open channels shall be calculated by an accepted form of the Manning equation. The Manning equation is commonly expressed as follows:

$$Q = \frac{1.486}{n} A R^{2/3} S_f^{1/2}$$

in which Q = Flow rate, in c.f.s.
 n = Roughness coefficient
 A = Area of water normal to flow, in ft.²
 R = Hydraulic radius
 S_f = Friction slope

C-2 Water Surface Profile Calculations continued.

When rearranged into a more useful form,

$$S_f = \frac{2gn^2}{2.21} \left[\frac{V^2}{2g} / R^{4/3} \right]$$

The loss of head due to friction throughout the length of reach involved (L) is calculated by:

$$h_f = S_f \cdot L$$

Refer to the Appendix for values of "n" for different materials and corresponding values of

$$\frac{2gn^2}{2.21}$$

C-2.4.2 Confluence or Junctions

Confluence or junctions shall be evaluated by the pressure and momentum theory and shall conform to closed conduit angle of confluence criteria, Section 8-5.1. Refer to Section F for cases and alternate solutions.

C-2.5 Side-Channel Spillway Inlets

When the main channel is relatively narrow and when the volume of side inflow is in the range between 3 and 6 percent of the main channel discharge, high waves are usually produced by the side inflow and are reflected downstream for a long distance, thus requiring additional wall height to preclude overtopping of the channel walls. This condition is amplified when the side inflow is at a greater velocity than the main channel. To eliminate these wave disturbances, the Los Angeles District of the Corps of Engineers has developed a side channel spillway inlet. The Corps may require this type of structure when outletting into one of their facilities. It shall also be used for District channels if high waves above the normal water surface cannot be tolerated. See Section F for the Corp's procedure and criteria.

C-2 Water Surface Profile Calculations continued.

C-2.6 TransitionsC-2.6.1 Subcritical Flow

For subcritical velocities less than 12 f.p.s., the angle of convergence or divergence between the center line of the channel and the wall shall not exceed $12^{\circ}30'$. The length of the transition (L) shall be determined from the following equation:

$$L \approx 2.5 \Delta B$$

where ΔB = The difference in channel width at the water surface between the upstream and downstream ends of the transition.

For subcritical velocities equal to or greater than 12 f.p.s., the angle of convergence or divergence between the center line of the channel and the wall shall not exceed $5^{\circ}45'$. The length (L) shall be determined from the following equation:

$$L \approx 5.0 \Delta B$$

Head losses for transitions with converging or diverging walls in subcritical flow conditions shall be determined by using the formulas in subsection B-2.3.2.

C-2.6.2 Supercritical Flowa. Divergent Walls

The angle of divergence between the center line of the channel and the wall shall not exceed $5^{\circ}45'$ or $\tan^{-1} F/3$ whichever is smaller. The length of the transition (L) is the longest length determined from the following equations:

$$L \approx 5.0 \Delta B$$

$$L \approx 1.5 \Delta B \cdot F$$

where F = Upstream Froude number based on depth of flow.

ΔB = The difference in channel width at the water surface.

C-2 Water Surface Profile Calculations continued.

b. Convergent Walls

Converging walls should be avoided when designing channels in supercritical flow; however, if this is impractical, the converging transition shall be designed to minimize wave action. The walls of the transition shall be straight lines.

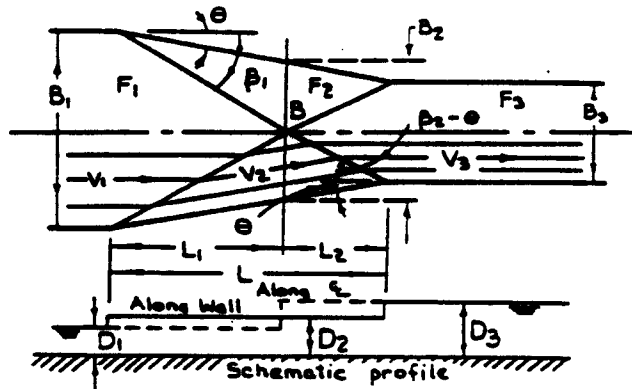

$$L = \frac{B_1 - B_3}{2 \tan \theta}$$

With the initial Froude number and the contraction ratio fixed, and with the continuity equation giving

$$\frac{B_1}{B_3} = \left(\frac{D_3}{D_1} \right)^{\frac{3}{2}} \times \frac{F_3}{F_1},$$

trial curves can produce the geometry of the contraction suggested above. The curves represent the equation

$$\tan \theta = \frac{\tan \beta_1 (\sqrt{1 + 8F_1^2 \sin^2 \beta_1} - 3)}{2 \tan^2 \beta_1 + \sqrt{1 + 8F_1^2 \sin^2 \beta_1} - 1}$$

Refer to Charts C-20, Page G-9 in the Appendix and to the example problem on Page F-22.

C-2 Water Surface Profile Calculations continued.

C-2.7 PiersC-2.7.1 General

The effect of piers on open channel design shall be considered at bridge crossings and where an open channel or box conduit not flowing full discharges into a length of multi-barreled box. This effect is especially important when flow is supercritical, and when transported debris impinges on the piers.

The total pier width shall include an added width for design purposes to account for debris. Inasmuch as the debris width to be used in design will vary with each particular situation, the District's Design Division shall be contacted during the preliminary design stages of a project for a determination of the appropriate width. Streamline piers should be used when heavy debris flow is anticipated. Refer to Section F for design data regarding streamline piers.

The water surface elevations at the upstream end of the piers shall be determined by equating pressure plus momentum. The water surface profile within the pier reach shall be determined by the Bernoulli equation. The water surface elevations at the downstream end of the piers may be determined by applying either the pressure plus momentum equation or the Bernoulli equation.

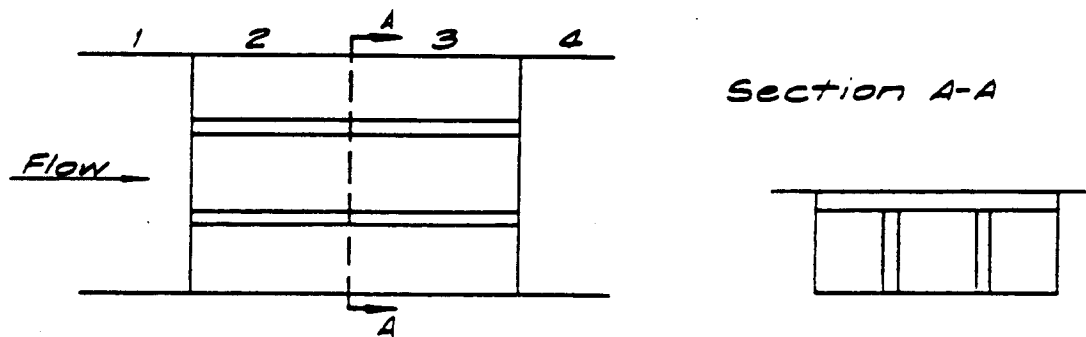
C-2.7.2 P + M Equation as Applied to Bridge Piers

Based on observations of bridge pier losses it's been found that there is a loss of momentum caused by impact against the pier which produces a loss in momentum equal to $M_1 (A_p/A_1)$. Therefore, the pressure plus momentum ($P_1 + M_1 - P_p$) should be reduced by the loss $M_1 (A_p/A_1)$ which changes the momentum term to $M_1 (A_1 - A_p/A_1) = M_1 (A_2/A_1)$.

$$P_1 + M_1 \frac{A_2}{A_1} - P_p = P_2 + M_2$$

$$P_3 + M_3 = P_4 + M_4 - P_p$$

C-2 Water Surface Profile Calculations continued.

where P_1 = Hydrostatic pressure in unobstructed channel

M_1 = Kinetic momentum in unobstructed channel

A_1 = Area of unobstructed channel

$A_2 = A_1 - A_p$ = Area of water within bridge

P_2 = Hydrostatic pressure within bridge based on net flow area

M_2 = Kinetic momentum within bridge based on net flow area

$P_p = K_p A_p \bar{Y}_p$ = Hydrostatic pressure of bridge pier

A_p = Area of piers

\bar{Y}_p = Centroidal moment arm of A_p about the hydraulic grade at the section

K_p = Pier factor

$K_p = 1.0$ for square-nosed piers

$K_p = 2/3$ for round-nosed piers

(Subscripts indicate the applicable section)

Chart C-10 is a graphical representation of the method presented above. Charts C-11 and C-12 are a graphical solution of the above $P + M$ equation.

C-2.7.3 Hydraulic Analysis

For subcritical or critical flow, the following cases, numbers 1 or 2, generally apply.

1. If the depth which balances the $P + M$ equation at the downstream end is equal to or above D_c within the piers, continue the water surface calculations to the upstream face of the bridge piers. Calculate the depth upstream of the piers by equating pressure plus momentum.

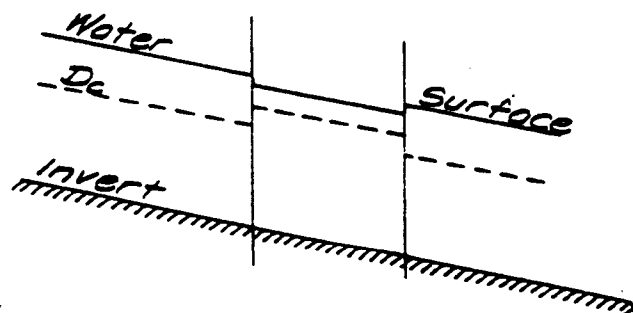

C-2 Water Surface Profile Calculations continued.

2. If at the downstream end of the piers no depth can be found to balance the $P + M$ equation, assume critical depth within the pier and calculate the water surface just downstream from the end of the pier. Calculate $P + M$ for this depth and its sequent depth. If the upper sequent depth provides a greater sum ($P + M$), a hydraulic jump occurs at the downstream end of the pier. If the lower sequent depth results in a greater sum ($P + M$) the hydraulic jump occurs some distance downstream from the pier. Within the pier, calculate the water surface to the upstream face and then calculate the depth just upstream of the face of the pier using the $P + M$ equation.

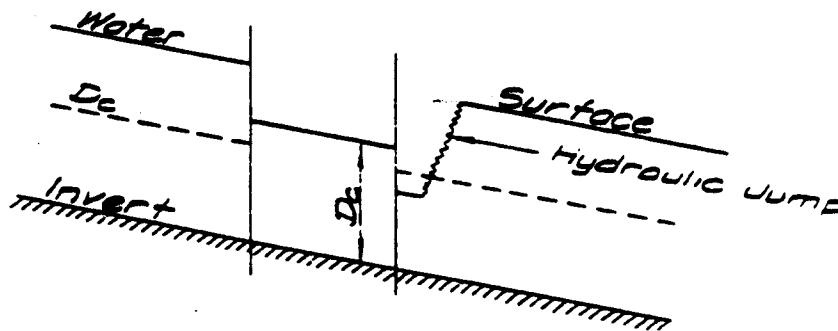

For supercritical flow the following cases, numbers 3 or 4, generally apply.

3. If the depth calculated by the $P + M$ equation just inside the upstream face of the pier is equal to or below critical depth continue the water surface to the downstream end of the pier and then calculate the depth just outside the pier by either the $P + M$ equation or the Bernoulli equation.

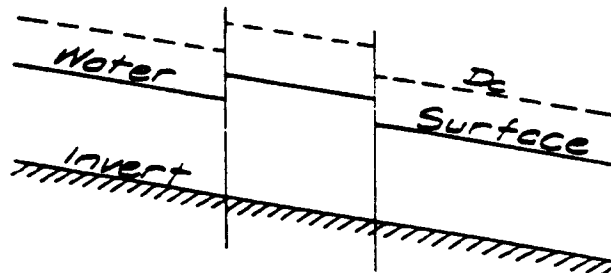

C-2 Water Surface Profile Calculations continued.

4. If, at the upstream end of the pier, no depth can be found to balance the $P + M$ equation, calculate $P + M$ for the depth of flow just outside the upstream end of the pier and its sequent depth. If the lower stage results in the greater sum ($P + M$), this indicates a hydraulic jump at the upstream face of the pier. If the upper stage results in the greater sum ($P + M$), this indicates a hydraulic jump some distance upstream from the pier. Assume critical depth just inside the upstream pier face and continue the water surface to the downstream end of the pier, and then calculate the depth just outside the pier by either the $P + M$ equation or the Bernoulli equation.

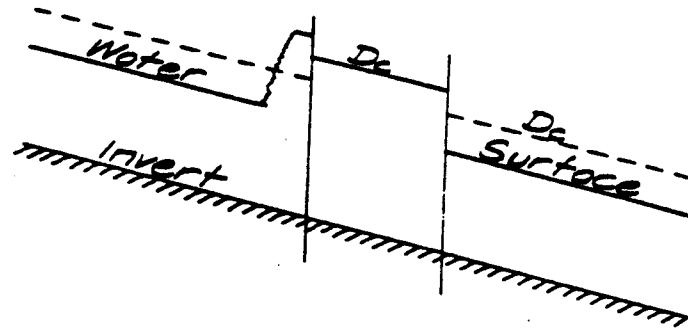

C-3 Curving Alignments

C-3.1 Superelevation

Superelevation is the rise in water surface at the outer wall above the mean depth (D) of flow in an equivalent straight reach, caused by centrifugal force in a curving alignment.

a. Rectangular Channels

For subcritical velocity, or for supercritical velocity where a stable transverse slope has been attained by an upstream easement curve, the maximum superelevation (S_{max}) can be calculated from the following equation:

$$S_{max} = \frac{v^2 b}{2gr}$$

C-3 Curving Alignments continued.

For supercritical velocity in the absence of an upstream easement curve, the maximum superelevation (S max) is given by the following equation:

$$S \text{ max} = \frac{V^2 b}{gr}$$

where V = Velocity of the flow cross section, in f.p.s.

b = Width of the channel, in ft.

g = Acceleration due to gravity

r = Radius of channel center line curve, in ft.

b. Trapezoidal Channels

For subcritical velocity, the maximum superelevation (S max) can be calculated from the following equation, and includes a 15 percent factor of safety.

$$S \text{ max} = 1.15 \frac{V^2 (b+2zD)}{2gr}$$

where z = cotangent of bank slope (ie: Horizontal to Vertical Ratio)

b = channel bottom width, in ft.

For supercritical velocity, curving alignments shall have easement curves with a maximum superelevation (S max) given by the following equation:

$$S \text{ max} = 1.3 \frac{V^2 (b+2zD)}{gr}$$

A 30 percent factor of safety is included.

C-3 Curving Alignments continued.

c. Unlined Channels

Pipe and wire, or rail and wire, channels shall be considered trapezoidal insofar as superelevation calculations are concerned. However, this does not apply to calculations of stream or channel cross-sectional areas.

d. Superelevation Allowance

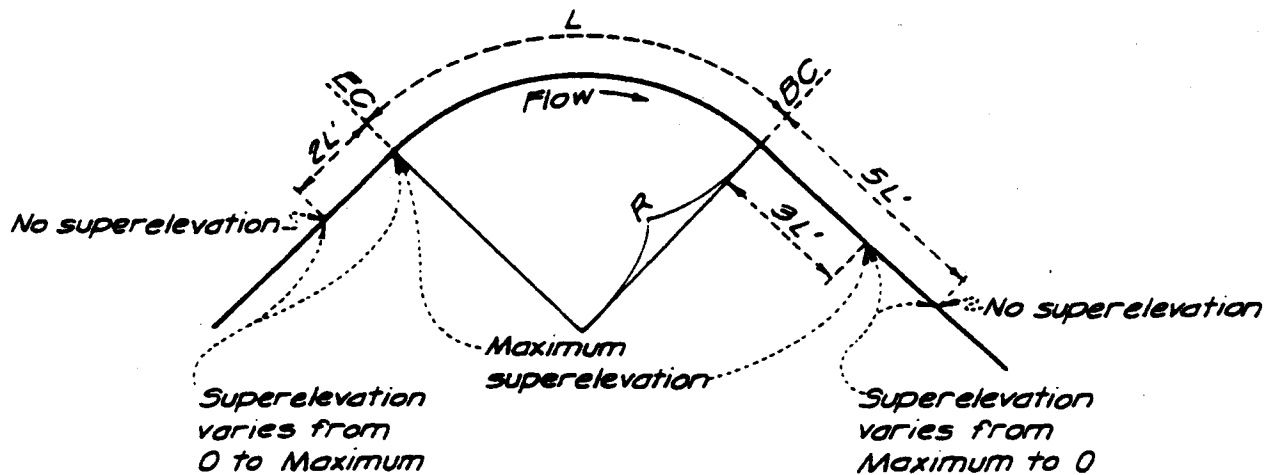

When determining superelevated water surfaces for freeboard (See Section C-4 for Freeboard) without easement curves, begin the surface change at a point $5 L'$ downstream of the B.C. of curve with no superelevation, taper to maximum superelevation at a point $3 L'$ downstream of the B.C. of curve, carry maximum superelevation to the E.C. of curve, and taper to no superelevation at a point $2 L'$ upstream of the E.C.

C-3 Curving Alignments continued.

where:

$$L' = \frac{T}{\tan \beta}$$

T = Top width

= b for rect. channels

= b + 2 Z D for trap. channels

β = Wave front angle

$$= \sin^{-1} \frac{\sqrt{gD}}{V}$$

$$= \sin^{-1} \frac{1}{F}$$

$$F = \text{Froude Number} = \frac{V}{\sqrt{gD}}$$

C-3.2 Easement Curves

Easement curves are alignment transition curves, employed upstream and downstream of circular curves, when supercritical flow exists in open channels. The purpose of the easements is to alter the transverse slope of the water surface and keep the water prism in constant static equilibrium against centrifugal force throughout the entire length of the easements and central circular curves, thus achieving minimum heights of superelevation with avoidance of cross-wave disturbances.

Circular easement curves are recommended in lieu of spiral transition curves for ease of design and construction. Also very little hydraulic advantage is gained by the use of the spiral. The circular easement curve consists of curved sections upstream and downstream of the main curve having a radius (2R), twice the main curve radius (R). See Section C-3.2.2.

C-3.2.1 Conditions Requiring Easement Curves

1. When the freeboard, above superelevated water surface (as calculated without an easement curve), is less than one foot.

C-3 Curving Alignments continued.

2. In reverse curves or on alignments where curves follow one another closely.
3. For any case where elimination of cross-wave disturbances is required. (If easement curves are not used, additional freeboard downstream of the curve may be necessary.)
4. In trapezoidal channels for all cases of supercritical velocity.

C-3.2.2 Length of Easement Curve L

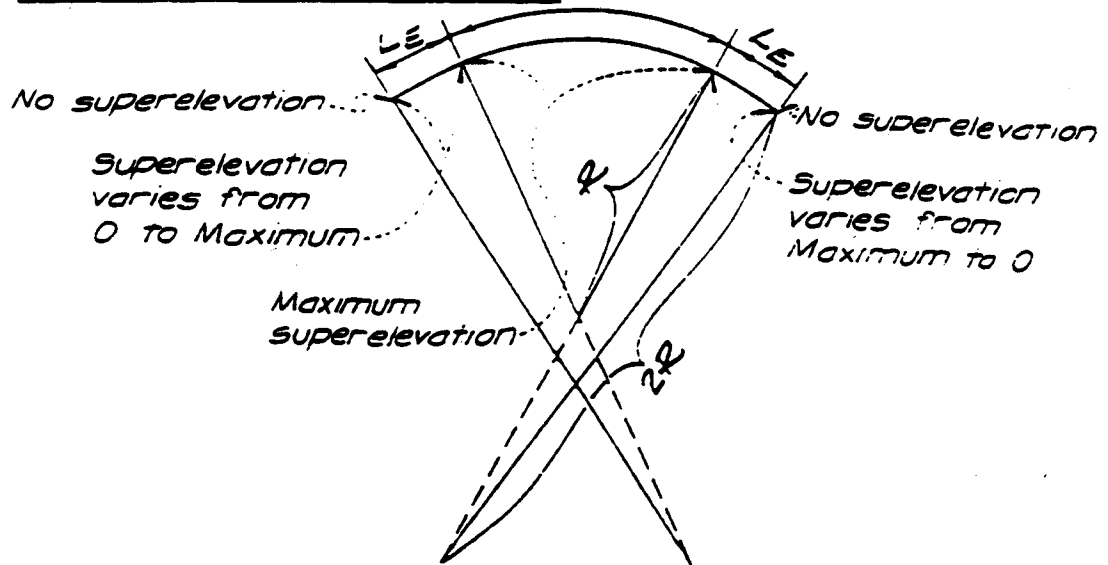

For rectangular channels, the length of easement curve (L_E) is given by the following equation:

$$L_E = .32 \frac{bV}{\sqrt{D}}$$

For trapezoidal and associated channel types, the length of easement curve (L_E) can be calculated as follows:

$$L_E = .32(b - 2zD) \frac{V}{\sqrt{D}}$$

Terms are defined hereinabove.

C-3.2.3 Superelevation Allowance

When determining superelevated water surfaces for freeboard (See Section C-4 for Freeboard) with easement curves, begin the surface change at the downstream end of the downstream easement curve with no superelevation, taper to maximum superelevation at the upstream end of the easement curve, carry maximum superelevation to the end of the main curve, and taper to no superelevation at the upstream end of the upstream curve. (See Figure in Section C-3.2.2)

C-3 Curving Alignments continued.

C-3.2.4 Right of Way

If easement curves are used, all circular curves for the center line of the intended right of way should have upstream and downstream tangent extension lengths of at least one-half of the calculated required easement curve length. The District's practice is to make the central circular curve of the channel center line concentric with and midway inside of, the right of way curves.

freeboard C-4 Freeboard

Freeboard is the additional wall height applied to a calculated water surface.

C-4.1 Rectangular Channels

1. For average flow velocities of 35 f.p.s., or less, add 2.0 feet. For curved alignments, add 2.0 feet or 1.0 feet above the superelevated water surface, whichever is greater.
2. For average flow velocities greater than 35 f.p.s., add 3.0 feet. For curved alignments, add 3.0 feet or 2.0 feet above the superelevated water surface, whichever is greater.
3. For supercritical flow where the depth is between D_c and $0.80 D_c$, the wall height shall be equal to the sequent depth, but not less than the heights required under 1 and 2 above.

C-4.2 Trapezoidal Channels and Associated Types

1. For average flow velocities of 35 f.p.s., or less, add 2.5 feet. For curved alignments, add 2.5 feet or 1.0 feet above the superelevated water surface, whichever is greater.
2. For average flow velocities greater than 35 f.p.s., add 3.5 feet. For curved alignments, add 3.5 feet or 2.0 feet above the superelevated water surface, whichever is greater.
3. For supercritical flow where the specific energy is equal to or less than 1.05 of the specific energy at D_c , the wall height shall be equal to the sequent depth, but not less than the heights required under 1 and 2 above.

C-5 Roll Waves

Roll waves, sometimes known as slug flow, are intermittent surges on steep slopes that will occur when the Froude Number (F) is greater than 2.0 and the channel invert slope (S_o) is greater

C-5 Roll Waves continued.

than the quotient, twelve divided by the Reynolds Number. When they do occur, it is important to know the maximum wave height at all points along the channel so that appropriate wall heights may be determined. Based on the experimental results of roll waves by Richard R. Brock, the maximum wave height can be estimated.

For details, see "Development of Roll Waves in Open Channels", Report No. KH-R-16, California Institute of Technology, July 1967. Refer also to Charts C-30, C-31 and C-32, and to the example problem on pages F-23 and F-24.

C-6 Other CriteriaC-6.1 Composite Linings

In locations where part of the channel cross section is unlined or the linings are composed of different materials, a weighted coefficient must be determined using the roughness factors for the materials as given in Chart F-04. If the lining materials are represented by the subscripts "a", "b" and "c", and the wetted perimeters by "P", the weighted value of "n" for the composite section is given by the following equation:

$$n = \left[\frac{P_a n_a^{3/2} + P_b n_b^{3/2} + P_c n_c^{3/2}}{P} \right]^{2/3}$$

C-6.2 Maximum Sidewall Slopes

The following sidewall slopes are generally the maximum values used for channels. If unusual conditions appear to warrant the use of greater side slopes than those listed, the District's Design Division should be consulted.

<u>Lining Material</u>	<u>Maximum Slope</u>
Portland Cement Concrete	Vertical
Gunite	Vertical
Asphaltic Concrete:	
less than 10' in height	1-1/2:1
10' to 20' in height	1-3/4:1
20' to 40' in height	2:1
Over 40' in height	2-1/2:1
Grouted Rock	1-1/2:1
Loose Rock	1-1/2:1

C-6 Other Criteria continued.

C-6.3 Unlined Channels

After full consideration has been given to the soil type, velocity of flow, desired life of the channel, economics, availability of materials, maintenance and any other pertinent factors, an unlined and unrevetted earth channel may be approved for use.

Generally, its use is acceptable where erosion is not a factor and where mean velocity does not exceed 3 f.p.s. Old and well-seasoned channels will stand higher velocities than new ones; and with other conditions the same, deeper channels will convey water at a higher nonerodible velocity than shallower ones.

Maximum side slope shall be determined pursuant to an analysis of soil reports. However, in general, slopes on fill should be 2:1 maximum. Slopes in cut should be 1-1/2:1 maximum.

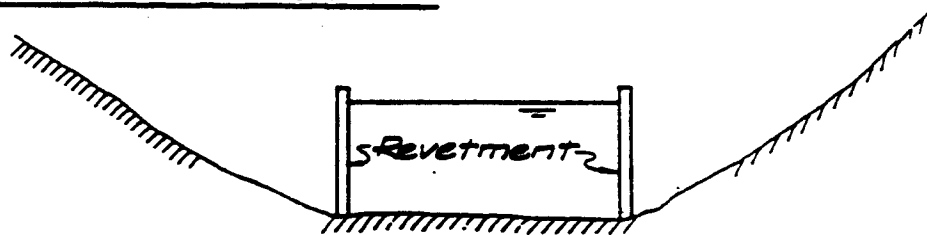
C-6.4 Revetted Channelsa. Cross-Sectional Area of Flow

For the typical cross section shown above, only the area between the two inside faces of the revetment shall be considered, for design purposes, to be the cross-sectional area of flow.

b. Stabilizers for Channels with Revetment

Cross-channel members of stabilizer units are placed such that the tops are at the level of the excavated channel bottom.

The distance (L) between stabilizers is determined from the following formula:

$$L = \frac{4.5}{S}$$

where S = Slope of the channel before the first design flow.

Hyd. Man.

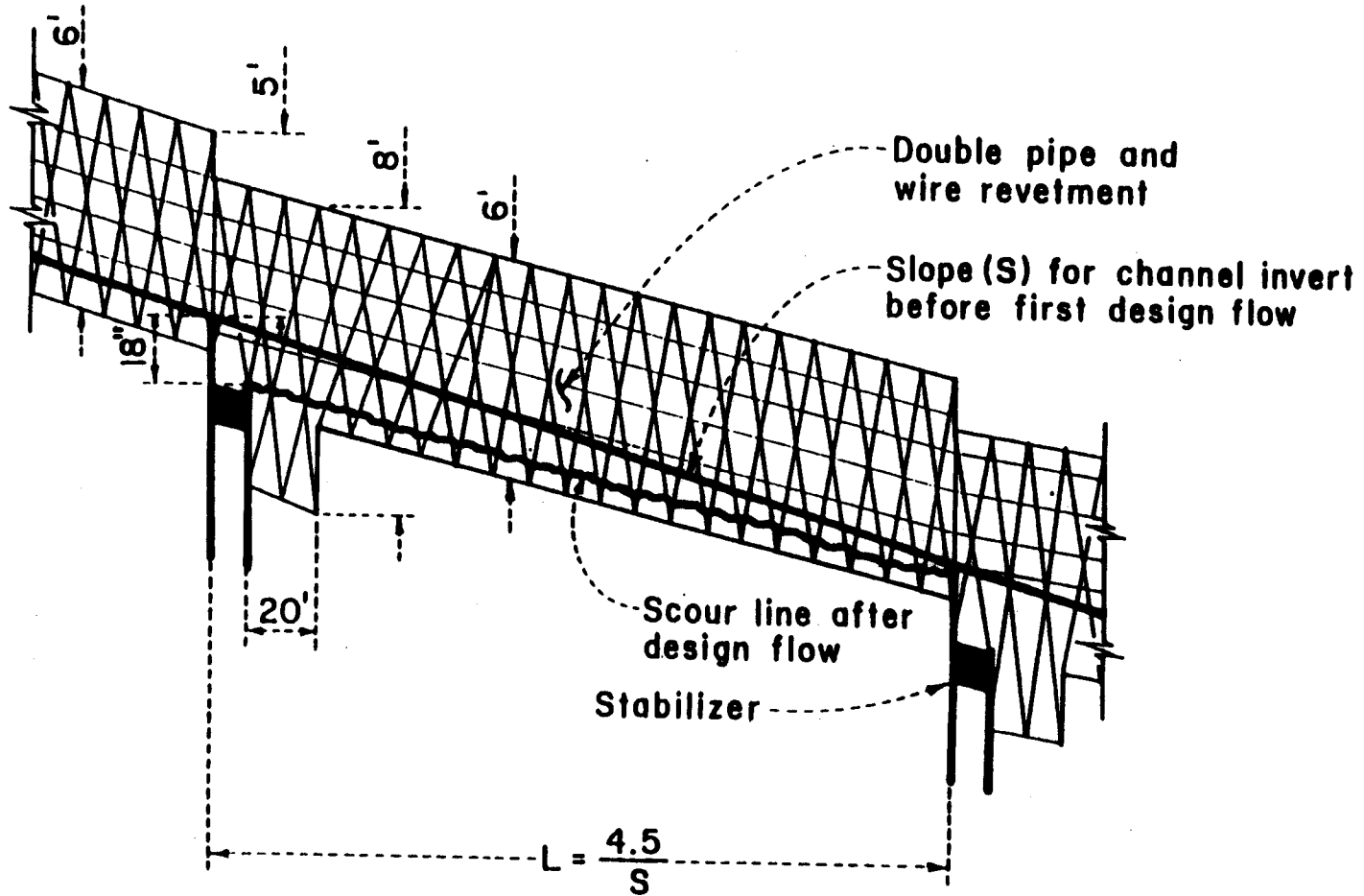

STABILIZER SPACING FOR CHANNEL WITH REVETMENT
NOT TO SCALE

SECTION D

C A T C H B A S I N S

Section DC A T C H B A S I N SD-1 Design Q

The District's Hydraulic Division will furnish the designer of District projects with a drainage map (Scale: 1" = 2000') and a channel design data sheet indicating main line design Q's and peak design Q's for individual subareas tributary to the main line. Subareas result from the initial breakdown by the District of the total drainage area and are designated by numbered circles on the drainage maps furnished by the District. Catch basin design Q's shall be determined by the following procedure:

1. Outline the drainage area map furnished by the District on a map with a scale of not less than 1" = 600'.
2. Outline the drainage area tributary to each proposed catch basin, designating this area with the corresponding subarea number and with a letter (2A, 2B, 2C, etc.). Drainage areas shall be differentiated by color.
3. Calculate the tributary area in acres for each catch basin. Discrepancies in drainage area boundaries with those furnished by the District should be discussed with the District's Design Division. If any problems remain, the conflicts should be resolved with the District's Hydraulic Division.
4. Assuming satisfactory drainage area relationships, the catch basin design Q shall be calculated as follows:

$$Q_{DES} = \frac{Q_P}{A_T} A$$

where A = Area in acres tributary to catch basin

A_T = Total area in acres of the appropriate subarea

Q_p = Peak Q from appropriate subarea, in c.f.s.

(Refer to the example problem on page F-29)

In cases where the main line design Q's are reduced because of a restricted outlet, the catch basin design Q's shall be reduced by the same percentage.

If, during the design of a project, it is determined that the proposed catch basin interception points will change the interception points assumed in the main line hydrology, then the main line Q's should be adjusted accordingly.

D-2 Required Data and Calculations

D-2.1 Street Flow Carrying Capacity

Submitted data shall include complete cross sections between property lines of streets at the proposed catch basins and of any streets which control the flow of water to the pertinent locations. Street cross sections shall indicate the following:

1. Dimensions from the street center line to the top of curb and property line.
2. Gutter slope at each catch basin.
3. Elevations for the top of curb, flow line, property line and street crown at each catch basin center line.
4. Curb batter.

Please refer to Charts Nos. D-01 to D-08, inclusive, for nomographs giving street capacities for some typical street sections.

V-DEPTH CALCS

D-2.2 Catch Basin Size and Type

Size and type of catch basin shall be determined by physical requirements and by inlet flow capacities given in Charts Nos. D-10 to D-26, inclusive. Criteria used, if other than those recommended in this section, shall be cited and accompanied by appropriate calculations.

D-2.3 Connector Pipe and "V" Depth Calculation

D-2.3.1 Single Catch Basins

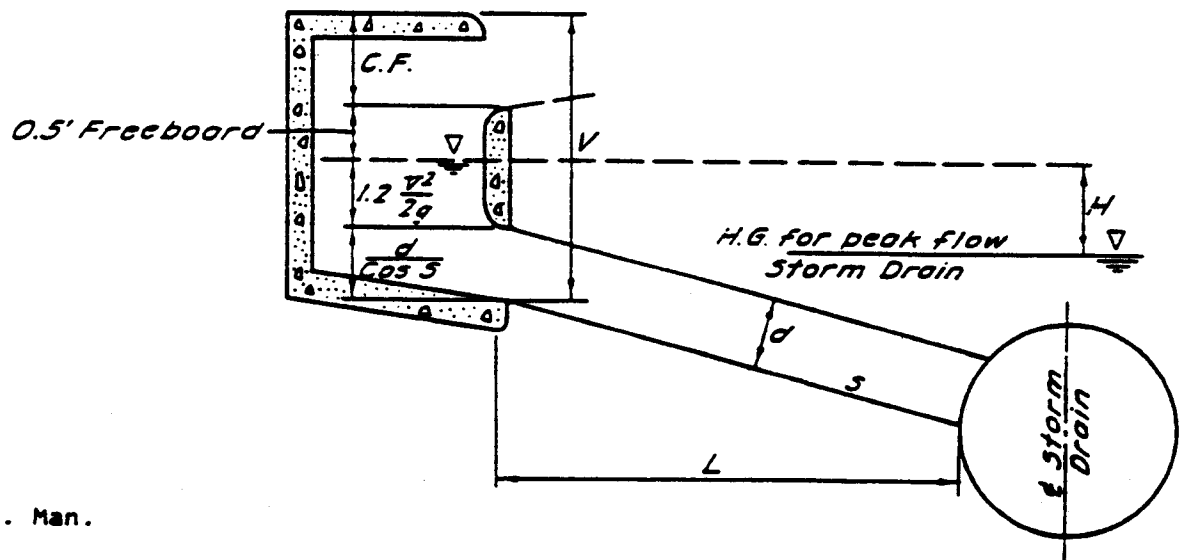

Hyd. Man.

D-2.3.1 Single Catch Basins continued.

Given the available head (H), the required connector pipe size can be determined from culvert equations, such as those given in King & Brater, "Handbook of Hydraulics", Section Four, fifth edition. Chart No. D-30 can be used for a nomographic solution of a culvert equation for culverts flowing full.

The minimum catch basin "V" depth shall be determined as follows:

$$V = C.F. + 0.5 + 1.2 \frac{v^2}{2g} + \frac{d}{\cos S}$$

where V = Depth of the catch basin, or "V" depth, measured in feet from the invert of the connector pipe to the top of the curb.

C.F. = Vertical dimension of the curb face at the catch basin opening, in feet.

v = Average velocity of flow in the connector pipe, in feet per second, assuming a full pipe section.

d = Diameter of connector pipe, in feet.

S = Slope of connector pipe.

The term $1.2 \frac{v^2}{2g}$ includes an entrance loss of .2 of the velocity head.

Assuming a curb face at the catch basin opening of 10 inches, which is the value normally used by most agencies, and $\cos S = 1$, the above equation may be simplified to the following:

$$V = 1.33 + 1.2 \frac{v^2}{2g} + d$$

Please refer to Chart No. D-31 for a graphical solution to the above equation for curb faces of 10 inches.

D-2.3.2 Catch Basins In Series

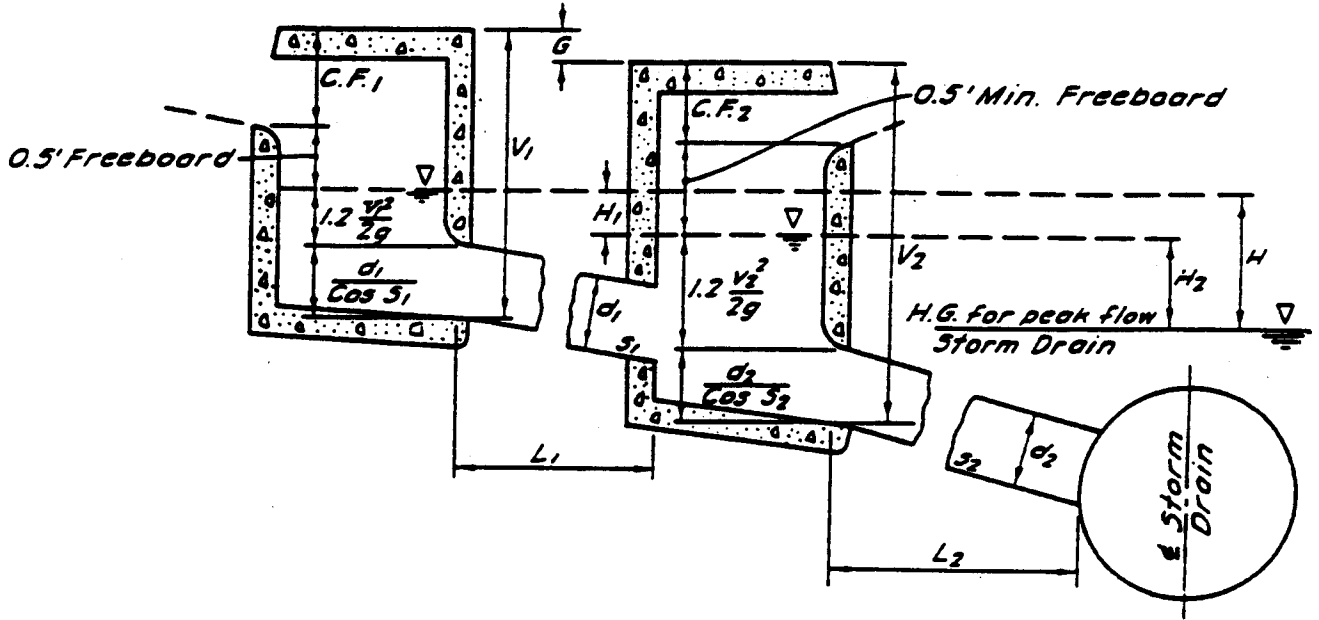

Select a connector pipe size for each catch basin, and determine the related head loss (H_1 , H_2) by means of a culvert equation, or by Chart No. D-30. The sum of head losses in the series shall not exceed the available head, i.e.,

$$H_1 + H_2 + \dots + H_n \leq H.$$

The minimum catch basin "V" depths shall be determined in the following manner:

1. The first catch basin "V" depth shall be calculated as for a single catch basin:

$$V_1 = 1.33 + 1.2 \frac{V_1^2}{2g} + d_1$$

D-2.3.2 Catch Basins in Series continued.

2. The second catch basin "V" depth shall be determined as follows:

$$V_2 = C.F._1 + 0.5 + H_1 + 1.2 \frac{V_2^2}{2g} + \frac{d_2}{\cos S_2} - G$$

Assuming again that $C.F._1 = 0.83$ and $\cos S_2 = 1$,

$$V_2 = 1.33 + H_1 + 1.2 \frac{V_2^2}{2g} + d_2 - G$$

3. The freeboard provided for the second catch basin generally shall not be less than 0.5 feet and shall be checked as follows:

$$FB_2 = V_2 - \frac{d_2}{\cos S_2} - 1.2 \frac{V_2^2}{2g} - C.F._2$$

If $C.F._2 = 0.83$ and $\cos S_2 = 1$,

$$FB_2 = V_2 - d_2 - 1.2 \frac{V_2^2}{2g} - 0.83$$

Where especially "tight" conditions prevail, the 0.5 feet freeboard requirement referred to above may be omitted. In such cases the difference between the gutter elevation and the hydraulic grade line elevation of the main line will be accepted as the available head.

4. Connector pipes between catch basins in series shall be checked for adverse slope by the following relationship:

$$V_2 - 0.5 > V_1 - G$$

The figure of 0.5 shown above is the standard 6-inch cross slope of the catch basin floors.

D-3 Other Criteria

D-3.1 General

- a. Existing drainage systems which are not required to carry any portion of the design Q of a proposed system may be designated to be abandoned in place upon completion of the proposed drain. Such existing drainage systems shall not be sealed or removed before completion of the proposed system, if needed to carry off storm water during the construction period. It shall be the designer's responsibility to ascertain the necessity of maintaining existing drainage systems in place.

Existing street or sidewalk culverts may be designated to have the interfering portions removed and the inlets sealed, or the culverts may be kept in operation and connected to the storm drain or to the back of a proposed catch basin. If the culvert is to be connected, a structural detail shall be provided. Refer to the District's Structural Design Manual for details.

Existing street or sidewalk culverts that do not interfere with construction shall be maintained in place.

If the existing culvert is located in, or is required to drain a sump, the designer shall make every effort to avoid removal of the culvert, especially in instances where the capacity of the proposed drain is less than that required for the correct design frequency, as set forth in Section A-1, page A-1.

- b. Catch basins shall be located within street rights of way unless otherwise approved by the District.

D-3.1 General continued.

- c. If, due to a lack of funds, a project is to have one or more cutoff points, each one corresponding to a different proposal, each cutoff point shall have a battery of catch basins at the upstream terminus sufficient to collect the flow carrying capacity of the street. Each battery of catch basins shall be designed with sufficient data regarding types and sizes of catch basins, connector pipe sizes and D-loads, "V" depths, local depressions, and whatever other information may be necessary to construct the system.

D-3.2 Catch Basins

- a. Grating-type catch basins are used on steep sloped streets (generally greater than 4%) where due to the high velocity of the street flow it is difficult to direct the water into a curb opening basin. Grating basins should generally not be used in sump conditions because of the possibility of debris clogging the grates.

The Catch Basin No. 7 is generally used with curb and gutter. The Catch Basin No. 4 is used less often and then only at curb openings for driveways, or where the distance between the street property line and the curb is so limited that a Catch Basin No. 7 cannot be constructed. The Catch Basins Nos. 5 and 5A are used in alleys, in streets with inverted crowns, and in similar situations.

The Catch Basin No. 6, a grating-type with upstream curb opening is used on steep sloped streets where debris may clog the gratings.

D-3.2 Catch Basins continued.

- b. Curb opening basins generally should be used where street slopes are less than 5 percent or where sump conditions exist.

Charts D-10A to D-10D and D-26 are to be used for curb opening catch basins.

The Catch Basin No. 8 can be used at driveways regardless of street slope, but is more effective on steep slopes than other catch basins. Charts Nos. D-20 to D-22, inclusive, are to be used for the Catch Basin No. 8.

A Catch Basin No. 8 should be avoided if the driveway is used by heavy truck traffic as past experience indicates damage to the top slab can occur.

The capacity of a Catch Basin No. 6 is calculated by adding 85 percent of the grating capacity to the capacity of the side opening for the appropriate drop in the local depression, with a reduced depth of flow at the grate.

- c. The construction of catch basins over 28 feet in length should be avoided. In lieu thereof, two shorter equivalent length basins should be designated.
- d. The number of catch basins to be connected in series should not exceed two. If the connection of more than two catch basins in series is unavoidable, consideration should be given to designing a lateral drain.
- e. The inside front-to-back dimension "b" which applies to catch basins, as shown on the District's standard drawings, may be reduced to avoid conflicts with structures or utilities. The reduction in the dimension "b" that will be necessary shall be determined by the designer, but in no case shall the dimension "b" be less than 30 inches. If reduction of the dimension "b" to the minimum specified herein is not sufficient to avoid the conflict, refer to Standard Drawing No. 2-D 461 for other possible solutions.

D-3.3 Local Depressions

- a. The Local Depression No. 2 usually has a drop of 4 inches and produces a curb face at the catch basin opening equal to the existing curb face plus 4 inches, unless otherwise shown on the general plan. The Local Depression No. 2 may be used if approval has been obtained by the jurisdictional agency for residential streets and other streets with light vehicular traffic and is applicable to side opening Catch Basins Nos. 1, 2 and 3, only.
- b. The Local Depression No. 3 has a drop of either 2 inches or 4 inches and can be used with Catch Basins No. 4, No. 7, and No. 6. The Local Depression No. 3 with a drop of four inches shall be used only with approval by the jurisdictional agency and on streets with light vehicular traffic.
- c. The Local Depression No. 4 has a drop of either 1 inch or 2 inches and can be used with Catch Basins Nos. 1, 2, 3, 6, 7 and No. 8, Case B. The Local Depression No. 4 shall be used on major streets carrying arterial traffic, on any other heavily traveled street, and in any situation where vehicles may be traveling in traffic lanes adjacent to curbs at relatively high speeds.

If, at any time during design, a local depression is changed, the length of opening of the corresponding catch basin shall be checked for size and changed, if necessary. At no time shall the local depressions be changed from a No. 2 to a No. 4 in the final design stages of a project by means of a General Note, unless all catch basins are reviewed.

- d. Other local depressions are detailed on the appropriate standard drawing for the Catch Basin No. 8, Cases A and B. Case A specifies a 12-inch curb face throughout length 'W' of the curb opening. Case B specifies a corresponding 9-inch curb face. A Local Depression No. 4 may be specified with Case B.

Local depressions are not used with Catch Basins Nos. 5 and 5A. The grates for these basins are installed in the plane of the existing street surface or may be depressed in situations where water may bypass the basin.

D-3.4 Connector Pipe

- a. The minimum diameter of connector pipe shall be 18 inches.

D-3.4 Connector Pipe continued.

- b. The horizontal alignment of connector pipes shall contain no angle points or bends, unless approved by the District.
- c. Connector pipes outletting into a pipe from both sides of a street should be offset 8 feet or more at the main line. Exceptions to this criterion shall be approved by the District.
- d. The minimum length of connector pipe to be installed between catch basins in series shall be 12 feet, unless prevented by field conditions.
- e. Catch basin connector pipes shall outlet at the downstream end of the catch basins, unless prevented by field conditions. Downstream, in this paragraph, refers to the direction of the gutter slope at the catch basin in question.
- f. Where feasible, connector pipes should be located so as to avoid, as much as possible, cutting into existing cross gutters and spandrels.
- g. Wherever possible, the minimum connector pipe slope shall be .01 (1 percent).

D-3.5 Inlet No. 1

The Inlet No. 1 can be used to collect water flowing in ditches, at the base of embankments, at locations where water cannot be collected in a feasible manner by catch basins, or where the construction of a catch basin would be of such a temporary nature as to be uneconomical.

The Inlet No. 1 shall not be used in watercourses subject to debris flows. In such cases, a concrete structure with a protection barrier or trashrack shall be used.

The Inlet No. 1 is detailed on the District's Standard Drawing No. 2-D265, and the three cases shown are to be used as follows:

- a. Case 1 should be specified when the reinforced concrete pipe to be installed can serve as the connector pipe for a future catch basin without being removed and reinstalled. The use of Case 1 must have the approval of the District's Design Division, due to the frequent maintenance necessary.
- b. Case 2 should be used wherever possible, and is preferred by the District.
- c. Case 3 is to be used wherever an Inlet No. 1 is to be installed directly over the top of a pipe or box conduit.

Notes and AssumptionsApplicable to Catch Basin ChartsCharts D-10, A,B,C and D

The design curves have been derived from the City of Los Angeles Bureau of Engineering Hydraulic Research Laboratory catch basin inlet capacity hydraulic model study of 1977.

Charts D-13, D-14 and D-15

These charts indicate grating capacities of standard City of Los Angeles gratings (Standard Plan No. B-2523) developed from hydraulic model studies for various values of "D" on the indicated slope and are applicable only to conditions shown on the corresponding charts. For complete information see: Office Standard No. 108, Bureau of Engineering, Storm Drain Design Division, City of Los Angeles.

Hydraulic model tests indicate that the use of 3/4-inch spacers (Standard Drawing No. 2-D 227) instead of 1-inch spacers on grating catch basins will reduce the interception capacity by as much as five percent when the grates are clean and completely covered with water. To account for this factor and the possibility of debris clogging the grates, the reduction in the interception capacity of grating basins shall be 15 percent.

Chart D-14

The dotted irregularity on Chart D-14 results from the hydraulic interference of the H-Beam supporting the adjoining gratings.

Charts D-20, D-21 and D-22

These charts indicate capacities developed from experimental hydraulic model studies, and may be used in determining the required length ("W") and/or the capacity ("Q") of catch basins of this type under various values of "D" and "W" and are applicable only to conditions shown on the corresponding charts. Office Standard No. 108, Bureau of Engineering, Storm Drain Design Division, City of Los Angeles.

Notes and Assumptions continued.

Charts D-13 to D-26, inclusive

These charts are not applicable to depths of flow in the gutter below 0.4 feet, nor to local depression drops greater than one inch. The District should be consulted for criteria to be used in determining catch basin sizes under these conditions.

SECTION E

P U M P S T A T I O N D E S I G N

Section E

P U M P S T A T I O N D E S I G N

The hydraulic design and operation of pump stations exclusive of discharge lines shall conform to criteria set forth in the District's Pump Station Design Manual.

Discharge lines shall be designed in accordance with criteria set forth in this manual, specifically Section B, "Criteria for Hydraulic Design: Closed Conduits".

The District's Hydraulic Division will furnish or confirm the inflow hydrographs to be used in designing pump stations and retention basins. Outside agencies should use District methods and standards in preparing inflow hydrographs.

SECTION F

M I S C E L L A N E O U S

Section FM I S C E L L A N E O U SF-1 Hydraulic JumpF-1.1 Location

If the water surface from a downstream control is computed until critical depth is reached, and similarly the water surface from an upstream control is computed until critical depth is reached, a hydraulic jump will occur between these controls and the top of the jump will be located at the point where pressure plus momentum, calculated for upper and lower stages, are equal.

F-1.2 Length

The length of a jump is defined as the distance between the point where roller turbulence begins and water becomes white and foamy due to air entrainment, and the point downstream where no return flow is observable.

- a. For rectangular channels, the length of jump (L) for the range of Froude Numbers between two and twenty, based on flow depth, is given by the following equation:

$$L = 6.9 (D_2 - D_1)$$

where D_1 and D_2 are the sequent depths.

- b. For trapezoidal channels, the length of jump (L) is given by the following equation:

$$L = 5 D_2 \left(1 + 4 \sqrt{\frac{t_2 - t_1}{t_1}} \right)$$

where t_1 = Width of water before jump
 t_2 = Width of water after jump.

Side Slope	$L / (D_2 - D_1)$
2:1	44.2
1:1	33.5
1/2:1	22.9
Vertical	6.9

F-2 Trashrack Head Loss

The head loss through a stationary trashrack can be determined from the following equation:

$$h_{TR} = K_{TR} \left(\frac{V_n^2}{2g} \right)$$

$$K_{TR} = 1.45 - 0.45 \frac{A_n}{A_g} - \left(\frac{A_n}{A_g} \right)^2$$

where K_{TR} = Trashrack coefficient

A_n = Net area through bars, in ft.²

A_g = Gross area of trashrack and supports (water area without trashrack in place), in ft.²

V_n = Average velocity through the rack openings
(Q/A_n), in f.p.s.

For maximum head loss, assume that the rack is 50% clogged, thereby reducing the value of A_n by 50%.

F-3 Side Channel Weirs

The Los Angeles District Corps of Engineers, as mentioned in Section C-2.5, has developed a side channel spillway inlet and may require this type of structure for drains outletting into their facilities. Their procedure for designing a side channel spillway is as follows:

1. Set the top of that part of the main channel wall at the location of the proposed spillway about 6 inches above the computed water surface level in the main channel.
2. Determine the length of spillway (L) required to discharge the design inflow of the side inlet by the following equation, in which the maximum value of H is not greater than one and one-half feet.

$$L = \frac{Q}{CH^{3/2}}$$

where Q = Discharge of side inlet, in c.f.s.

C = Weir coefficient

H = Depth of water over the crest of the side inlet.
in feet.

F-3 Side Channel Weirs continued.

3. Determine the depth of flow in the approach side channel at the upstream end of the spillway.
4. Set the side channel invert elevation at the upstream end of the spillway at an elevation below the spillway crest a distance equal to the water depth as determined in 3., above, minus the assumed head on the spillway.
5. Set the side channel invert slope equal to the spillway and the main channel water-surface slopes.
6. By trial, determine the width of the side channel required to maintain a constant depth of flow at several points downstream from the upstream end of the spillway. The discharge at each of these points is assumed to be the difference between the initial discharge less the amount spilled over that part of the spillway as computed by $CLH^{3/2}$, in which C is 3.087 and H is equal to the critical depth over the crest (neglecting the velocity of approach).
7. Plot the widths thus determined for the side channel on the channel plan and approximate a straight or curved line through them to locate the point of intersection of this line and the main channel wall.
8. If the length between the assumed point at the upstream end of the spillway and this intersection point is equal to the length determined in 2., above, the angle at the intersection indicates the required convergence for the side channel.
9. From the final layout determine the width and recompute the water surface in the side channel for the final design. The discharge over each portion of the spillway is calculated by using the average head between the two sections considered.

Refer to pages F-25 to F-27, inclusive, for an example problem involving the design of a side channel spillway, and to page F-28 for a typical plan.

F-4 Pier Extensions

Pier extensions of a streamlined nature, as mentioned in Section C-2.7.1, should be used when heavy debris flow is anticipated.

F-4 Pier Extensions continued.

In supercritical flow the addition of a specified width to account for the assumed amount of debris may result in impractical and costly structures. In lieu of assuming additional pier width for debris, the use of streamline pier extensions should be investigated. Unless an unusual quantity of debris is anticipated, it can be assumed that the major portion of the debris will not cling to the pier extension.

Pier extensions should be designed using the criteria indicated in the figure below.

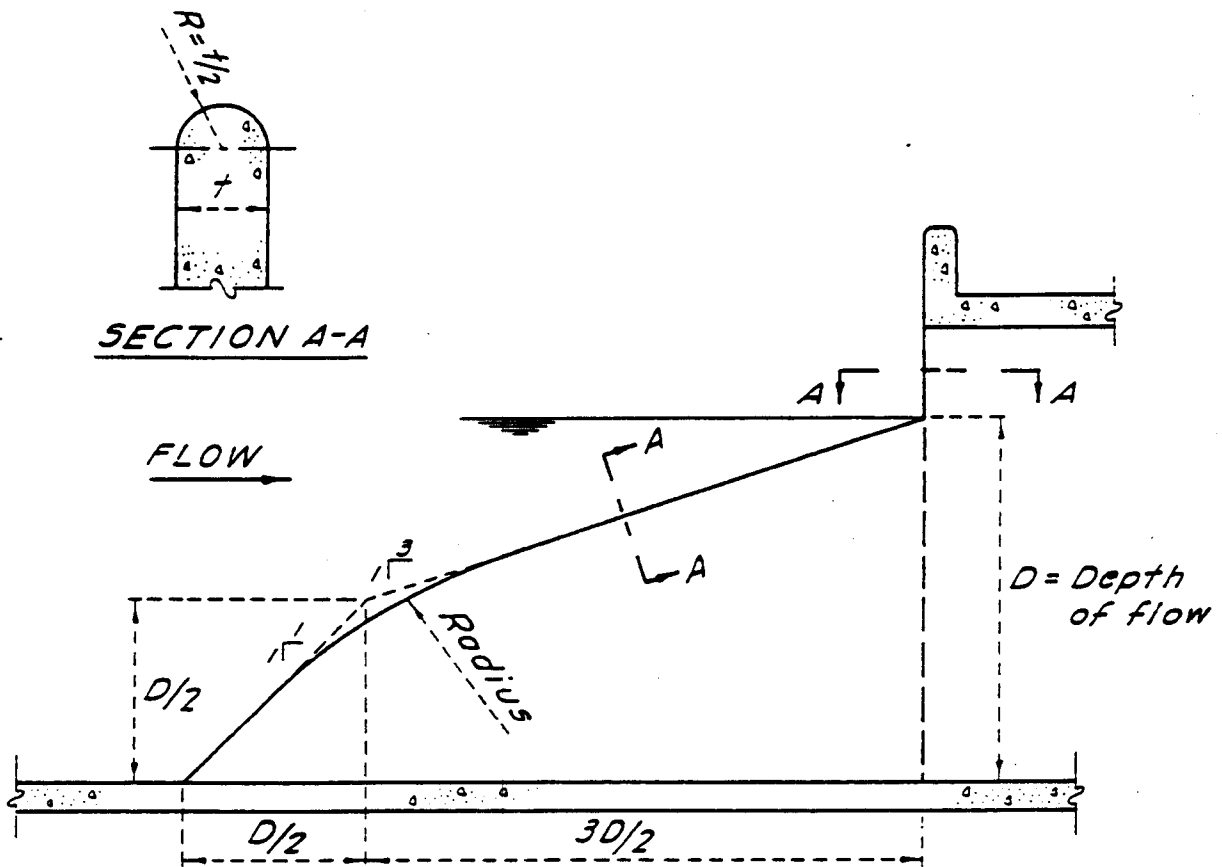

The City of Los AngelesThompson Equation

The Thompson Equation for junctions is described by the following:

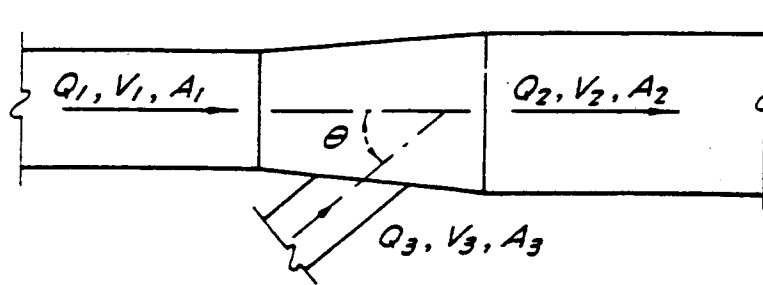

$$\Delta y \cdot A_{avg} = \frac{Q_2 V_2 - Q_1 V_1 - Q_3 V_3 \cos \theta}{g}$$

where Δy = Difference in hydraulic gradient for the two end sections, in feet.

A_{avg} = Average area, in feet² = $1/6 (A_1 + 4A_m + A_2)$ or, for practical use, $1/2 (A_1 + A_2)$

A_m = Mean area of flow, in feet².

The above equation is applicable only to prismatic and circular conduits or channels. The friction force may be considered negligible or can be calculated and taken into account.

For details of the above method, refer to Office Standard No. 115, Hydraulic Analysis of Junctions, 1968 edition, Storm Drain Design Division, Bureau of Engineering, City of Los Angeles.

In the following compilations:

γ_w , the unit weight of water, has been omitted since it appears in all terms.

- (2) The assumptions are made that the cosines of the invert slopes equal unity and that the tangents and sines of the friction slopes are equal.

The general equilibrium equation for all cases is:

$$P_2 + M_2 = P_1 + M_1 + M_3 \cos \theta + P_i + P_w - P_f$$

Where P_1 = hydrostatic pressure on section 1

P_2 = hydrostatic pressure on section 2

P_i = horizontal component of hydrostatic pressure on invert

P_w = axial component of hydrostatic pressure on walls

P_f = retardation force of friction
(S_1 and S_2 are friction slopes - see Kings Hdbk.)

M_1 = momentum of moving mass of water entering junction at section 1

M_2 = momentum of moving mass of water leaving junction at section 2

$M_3 \cos \theta$ = axial component of momentum of the moving mass of water entering the junction at section 3

CASE 1. OPEN TRAPEZOIDAL CHANNEL

$$M_1 = \frac{Q_1^2}{(b_1 + z_1 D_1) g D_1}$$

$$M_2 = \frac{Q_2^2}{(b_2 + z_2 D_2) g D_2}$$

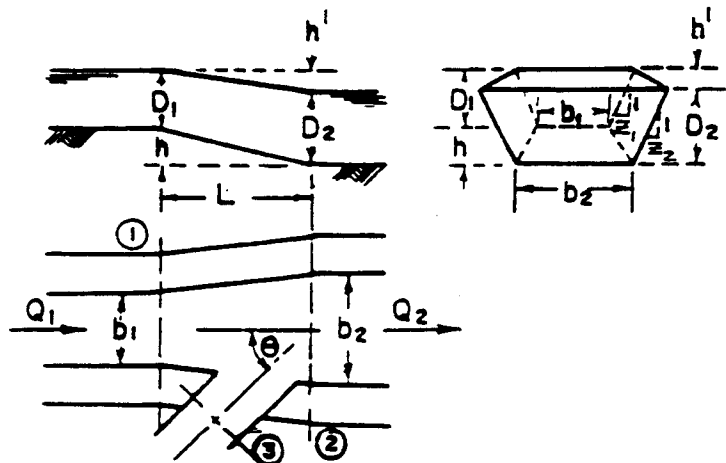

$$M_3 \cos \theta = \frac{(Q_2 - Q_1)^2}{A_3 g} (\cos \theta) \quad \text{where } A_3 = \text{water area at section 3}$$

Page F-7

$$P_1 = \frac{D_1^2}{6} \cdot (3b_1 + 2z_1 D_1)$$

$$P_2 = \frac{D_2^2}{6} \cdot (3b_2 + 2z_2 D_2)$$

$$P_1 = \left(\frac{b_1 + b_2}{2} \right) h \left[D_1 + \frac{(D_2 - D_1)(b_1 + 2b_2)}{3(b_1 + b_2)} \right]$$

$$P_w = \frac{D_1 + D_2}{4} \left[\frac{b_1 + b_2}{2} (D_1 - D_2) + h' (z_1 D_1 + z_2 D_2) + (b_2 + z_2 D_2) D_2 - (b_1 + z_1 D_1) D_1 \right]$$

$$P_f = \frac{L(s_1 + s_2)}{4} \left[(b_1 + z_1 D_1) D_1 + (b_2 + z_2 D_2) D_2 \right]$$

CASE 2. OPEN RECTANGULAR CHANNEL

$$M_1 = \frac{Q_1^2}{b_1 D_1 g}$$

$$M_2 = \frac{Q_2^2}{b_2 D_2 g}$$

$$M_3 \cos \theta = \frac{(Q_2 - Q_1)^2}{A_3 g} (\cos \theta)$$

$$P_1 = \frac{b_1 D_1^2}{2}$$

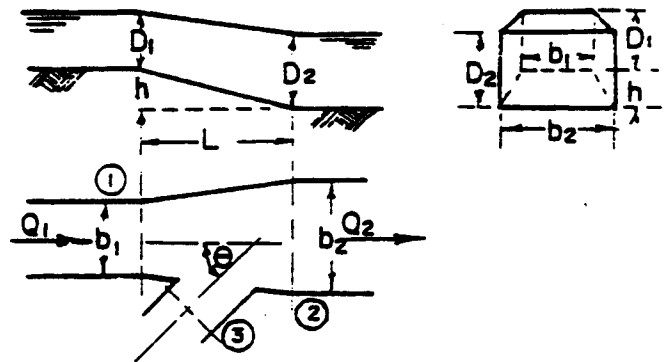

Where $A_3 = \text{water area at section 3}$

$$P_2 = \frac{b_2 D_2^2}{2}$$

$$P_1 = \left(\frac{b_1 + b_2}{2} \right) h \left[D_1 + \frac{(D_2 - D_1)(b_1 + 2b_2)}{3(b_1 + b_2)} \right]$$

$$P_w = \frac{D_1 + D_2}{4} (b_2 - b_1) \left[D_1 + \frac{(D_2 - D_1)(D_1 + 2D_2)}{3(D_1 + D_2)} \right]$$

$$P_f = \frac{L(s_1 + s_2)}{4} \cdot (b_1 D_1 + b_2 D_2)$$

CASE 3. RECTANGULAR BOX UNDER PRESSURE

$$M_1 = \frac{Q_1^2}{b_1 d_1^3}$$

$$M_2 = \frac{Q_2^2}{b_2 d_2^3}$$

$$M_3 \cos \theta = \frac{(Q_2 - Q_1)^2}{A_3^2} (\cos \theta)$$

$$P_1 = b_1 d_1 \left(D_1 - \frac{d_1}{2} \right)$$

$$P_2 = b_2 d_2 \left(D_2 - \frac{d_2}{2} \right)$$

$$P_i = \frac{b_1 + b_2}{2} \left(d_2 - \frac{d_1}{2} \right) \left[D_1 + \frac{(D_2 - D_1)(b_1 + 2b_2)}{3(b_1 + b_2)} \right]$$

$$P_v = \frac{d_1 + d_2}{4} (b_2 - b_1) \left[D_1 + D_2 - \frac{d_1 + d_2}{2} \right]$$

$$P_f = \frac{L(s_1 + s_2)}{4} (b_1 d_1 + b_2 d_2), \dots \text{where } s = \left[\frac{Q_0 (btd)^{2/3}}{.936 (bd)^{5/3}} \right]^2$$

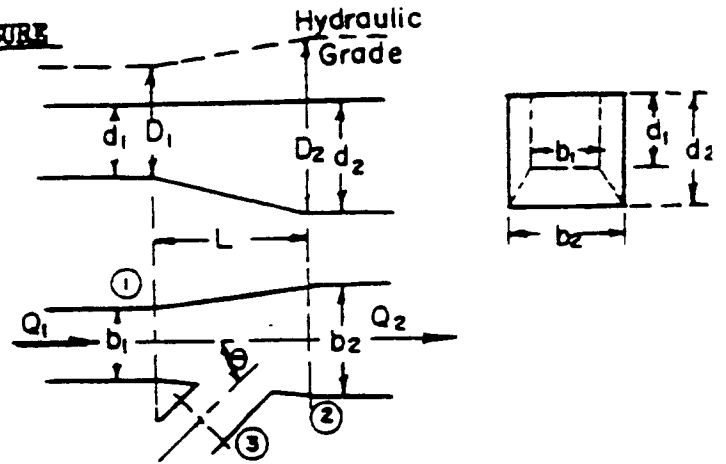

Where A_3 = water area at section 3

CASE 4. CIRCULAR CONDUIT UNDER PRESSURE, PIPE INLET

$$M_1 = \frac{Q_1^2}{25.2 d_1^2}$$

$$M_2 = \frac{Q_2^2}{25.2 d_2^2}$$

$$M_3 \cos \theta = \frac{(Q_2 - Q_1)^2}{252 d_3^2} (\cos \theta)$$

$$P_1 = .784 d_1^2 \left(D_1 - \frac{d_1}{2} \right)$$

$$P_2 = .784 d_2^2 \left(D_2 - \frac{d_2}{2} \right)$$

$$P_i = 0$$

$$P_v = .392 \left[(d_2^3 - d_1^3) + (d_2^2 - d_1^2)(D_1 + D_2 - d_1 - d_2) \right]$$

$$P_f = .196 L(s_1 + s_2) (d_1^2 + d_2^2), \dots \text{where } s = \left(\frac{2n}{.463 d^{2/3}} \right)^2$$

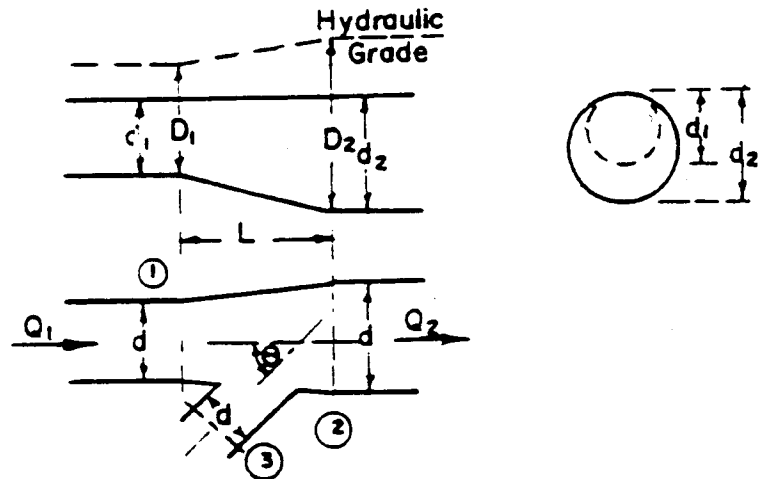

CASE 5. CIRCULAR CONDUIT FLOWING PARTIALLY FULL, PIPE INLET

$$M_1 = K_1 \left(\frac{Q_1}{d_1} \right)^2$$

$$M_2 = K_2 \left(\frac{Q_2}{d_2} \right)^2$$

$$M_3 \cos \theta = \frac{(Q_2 - Q_1)^2}{25.2 d_3^2} (\cos \theta)$$

$$P_1 = C_1 d_1^3$$

$$P_2 = C_2 d_2^3$$

$$P_i = 0$$

$$P_w = A_2 \bar{y}_2 - A_1 \bar{y}_1 + \frac{h'}{2} (A_2 + A_1) + \frac{(h')^2}{12} (T_2 - T_1)$$

$$P_f = \frac{L(s_1 + s_2)}{4} (A_1 + A_2)$$

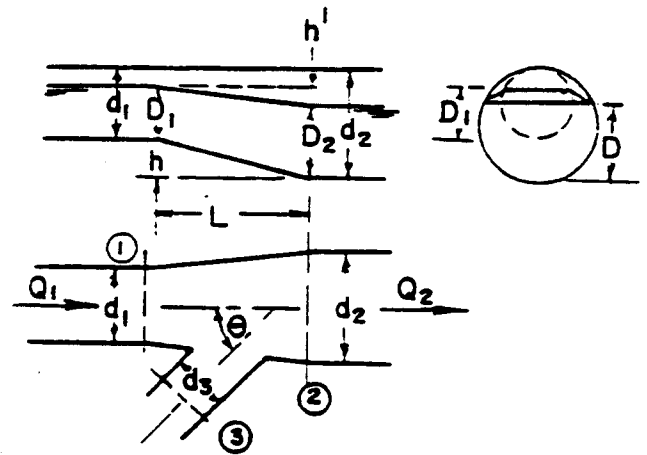

For tabulated values of C and K, see Chart No. F-03

See King "Hdbk of Hyd", for A_1 , \bar{y} and T

*WHERE $h' = h + D_1 - D_2$, THE TERM $\frac{(h')^2}{12} (T_2 - T_1)$ IS USUALLY NEGLIGIBLE.

EXAMPLE PROBLEMS

1. Design a transition connecting a rectangular channel 15 feet wide, design capacity of 1600 c.f.s. and normal depth of 5.0 feet, with a rectangular channel 16.5 feet wide, design capacity of 2500 c.f.s. and normal depth of 6.5 feet. The submerged outfall of a 9'3" wide by 4'6" deep box is located in the transition. The angle of confluence is 30°.

Page F-10

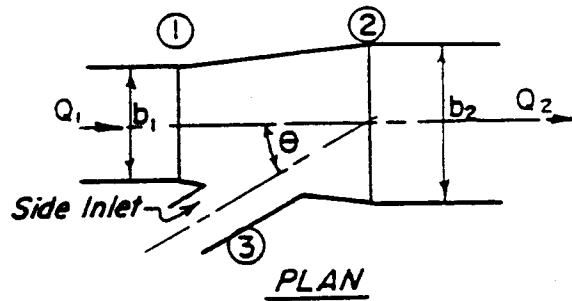
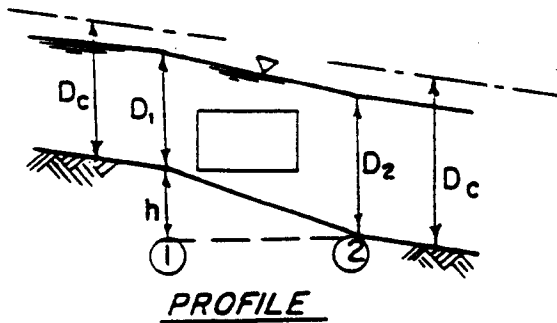

Given:

$Q_1 = 1600 \text{ cfs}$
 $b_1 = 15.0 \text{ ft}$
 $D_1 = 5.0 \text{ ft}$
 $A_1 = 75.0 \text{ sq. ft}$
 $v_1 = 21.3 \text{ fps}$

$Q_2 = 2500 \text{ cfs}$
 $b_2 = 16.5 \text{ ft}$
 $D_2 = 6.5 \text{ ft}$
 $A_2 = 107.3 \text{ sq. ft}$
 $v_2 = 23.3 \text{ fps}$

$Q_3 = 900 \text{ cfs}$
 $A_3 = 41.6 \text{ sq. ft}$
 $v_3 = 21.6 \text{ fps}$
 $\theta = 30^\circ$
 $h = ?$
 $L = ?$

Determination of Length

$$L = \frac{b_3}{\sin \theta} \text{ or } \frac{(b_2 - b_1) 10}{2} \text{ Which ever is greater.}$$

$$= \frac{9.25}{0.5} = 18.5', \dots \text{ Use } 22'$$

Eq'n 1 $M_1 = \frac{Q_1^2}{b_1 D_1 g} = \frac{1600^2}{(15)(5.0)(32.2)} = 1060$

Eq'n 2 $M_2 = \frac{Q_2^2}{b_2 D_2 g} = \frac{2500^2}{(16.5)(6.5)(32.2)} = 1810$

Eq'n 3 $M_3 \cos \theta = \frac{(Q_2 - Q_1)^2}{A_3 g} \cos \theta = \frac{900^2}{(41.6)(32.2)} \cdot 0.866 = 523$

Eq'n 4 $P_1 = \frac{b_1 D_1^2}{2} = \frac{(15.0)(5.0)^2}{2} = 188$

Eq'n 5 $P_2 = \frac{b_2 D_2^2}{2} = \frac{(16.5)(6.5)^2}{2} = 349$

Eq'n 6 $P_i = \frac{b_1 + b_2}{2} \left[D_1 + \frac{(D_2 - D_1)(b_1 + 2b_2)}{3(b_1 + b_2)} \right] (h)$

$$= \frac{15.0 + 16.5}{2} \left[5.0 + \left(\frac{6.5 - 5.0}{3} \right) \left(\frac{15.0 + 2(16.5)}{15.0 + 16.5} \right) \right] (h) = 90.75 h$$

Hyd. Man.

Example Problem 1, continued.

$$\begin{aligned} \text{Eq'n 7 } P_w &= \frac{D_1 + D_2}{4} (b_2 - b_1) \left[D_1 + \frac{(D_2 - D_1)(D_1 + 2D_2)}{3(D_1 + D_2)} \right] \\ &= \frac{(5.0 + 6.5)(16.5 - 15.0)}{4} \left[5.0 + \left(\frac{6.5 - 5.0}{3} \right) \left(\frac{5.0 + 2(6.5)}{5.0 + 6.5} \right) \right] = 25 \end{aligned}$$

$$\text{Eq'n 8 } P_f = \frac{L(s_1 + s_2)(b_1 D_1 + b_2 D_2)}{4} = \frac{22(.014)(182.2)}{4} = 14.1 \quad (P_f \text{ IS USUALLY NEGLECTED.})$$

$$\text{Eq'n 9 } P_2 + M_2 = P_1 + M_1 + M_3 \cos \theta + P_i + P_w - P_f$$

$$349 + 1810 = 188 + 1010 + 523 + 90.75h + 25 - 14$$

$$h = 4.16' \text{ drop invert through transition}$$

2. To review a transition in a rectangular channel with side inlet submerged

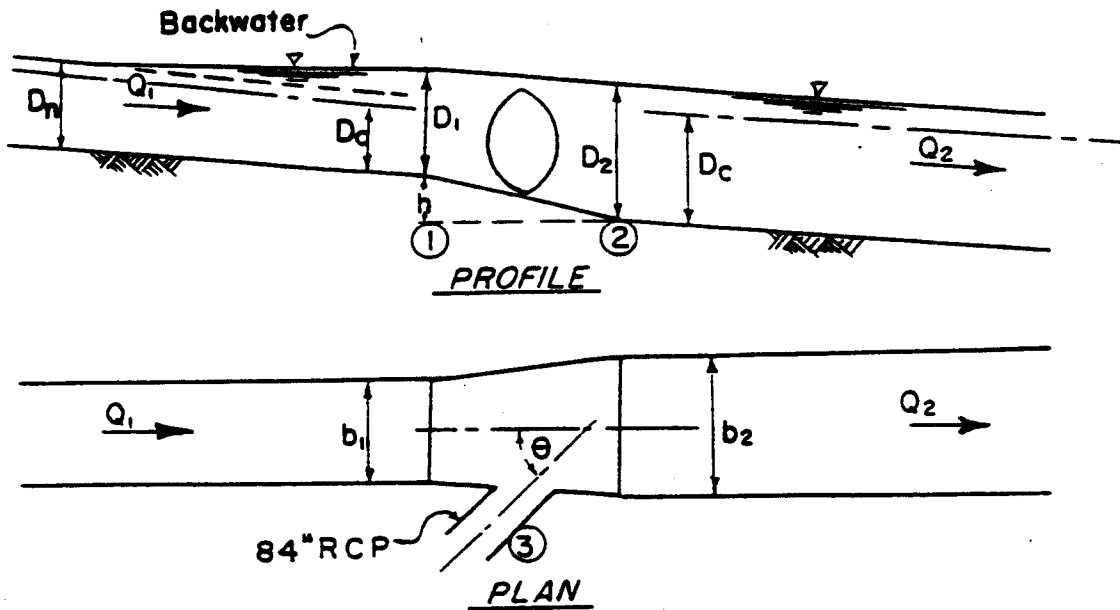

Given:

$Q_1 = 1400$ cfs
 $b_1 = 15.0$ ft
 $D_n = 6.6$ ft
 $h = 2.5$ ft
 $D_1 = ?$

$Q_2 = 2000$ cfs
 $b_2 = 16.5$ ft
 $D_2 = 9.5$ ft
 $A_2 = 156.8$ sq ft
 $v_2 = 12.8$ fps

$Q_3 = 600$ cfs
 $d_3 = 84''$ RCP = 7.0 ft
 $A_3 = 38.5$ sq ft
 $v_3 = 15.6$ fps
 $\theta = 45^\circ$

At section 1

$$D_c = \sqrt[3]{\frac{(1400)^2}{(150)(32.2)}} = \sqrt[3]{271} = 6.47'$$

At section 2

$$D_c = \sqrt[3]{\frac{(2000)^2}{(16.5)^2(32.2)}} = \sqrt[3]{456} = 7.70'$$

Since $D_n > D_c$ for both sections, the flow is sub-critical. Therefore calculate upstream from section 2.

Eq'n 1 $M_1 = \frac{(1400)(1400)}{(32.2)(15D_1)} = \frac{4058}{D_1}$

Eq'n 2 $M_2 = \frac{2000^2}{(16.5)(9.5)(32.2)} = 795$

Hyd. Man.

$$\text{Eq'n 3 } M_3 \cos \theta = \frac{600^2}{38.5(32.2)} (.707) = 206$$

$$\text{Eq'n 4 } P_1 = \frac{150 D_1^2}{2} = 7.5 D_1^2$$

$$\text{Eq'n 5 } P_2 = \frac{(16.5)(9.5)^2}{2} = 745$$

$$\text{Eq'n 6 } P_i = \frac{(15.0+16.5)}{2} (2.5) D_1 + \left(\frac{9.5-D_1}{3}\right) \left(\frac{15.0+2(16.5)}{15.0+16.5}\right) = 190 + 19.38 D_1$$

$$\text{Eq'n 7 } P_w = \frac{1}{4} (D_1+9.5)(16.5-15.0) D_1 + \left(\frac{9.5-D_1}{3}\right) \left(\frac{D_1+2(9.5)}{D_1+9.5}\right) = 0.250 D_1^2 + 2.37 D_1 + 23$$

Eq'n 8 P_f is neglected in this exmple.

$$\text{Eq'n 9 } P_2 + M_2 = P_1 + M_1 + M_3 \cos \theta + P_i + P_w - P_f$$

$$745 + 795 = 7.5 D_1^2 + \frac{4058}{D_1} + 206 + 190 + 19.38 D_1 + 0.250 D_1^2 + 2.37 D_1 + 23 - 0$$

$$7.750 D_1^2 + \frac{4058}{D_1} + 21.75 D_1 = 1121$$

By trial and error

$$D_1 = 7.5, \quad 436 + 541 + 163 = 1140$$

$$D_1 = 7.2, \quad 402 + 564 + 154 = 1120$$

Therefore the depth of section 1 will be 7.2'

3. REVIEW OF TRANSITION IN CIRCULAR CONDUIT FLOWING PARTIALLY FULL, PIPE INLET. (See Summary, Pg. 4)

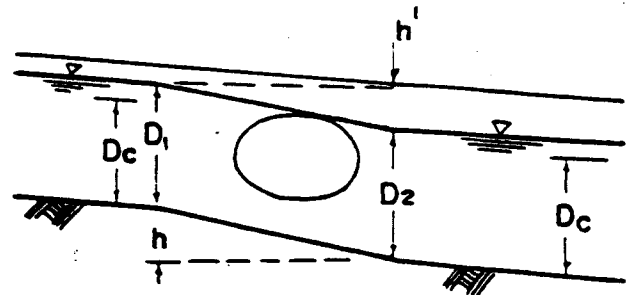
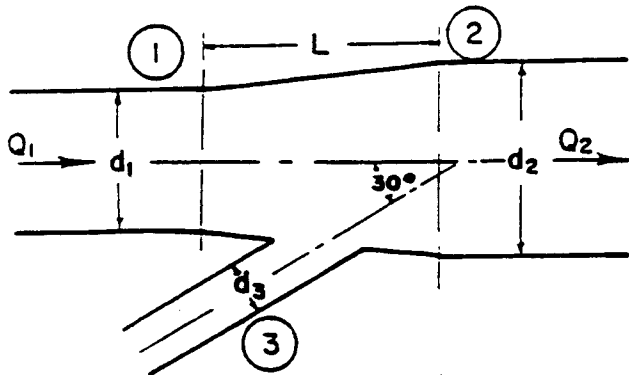

Given:

$d_1 = 66''$	$Q_1 = 200 \text{ cfs}$	$S_1 = .004$	$h = 0.5'$	$D_1 = ?$
$d_2 = 72''$	$Q_2 = 250 \text{ cfs}$	$S_2 = .0036$	$D_2 = 4.83$	
$d_3 = 30''$	$Q_3 = 50 \text{ cfs}$	$\theta = 30^\circ$	$L = 10'$	

At Section 2: $D_c = 4.33$ $D_n = 4.83$, At Section 1: $D_c = 3.96$ $D_n = 4.25$

Since $D_n > D_c$ for both sections, flow is sub-critical. Therefore calculate upstream from Section 2.

$$P_2 + M_2 = P_1 + M_1 + M_3 \cos \theta + P_i + P_w - P_f$$

$$\text{Eq'n 1 } M_1 = \frac{K_1(Q_1)^2}{(d_1)^2} = 1322 K_1$$

$$\text{Eq'n 2 } M_2 = \frac{K_2(Q_2)^2}{(d_2)^2} = 79.6$$

$$\text{Eq'n 3 } M_3 \cos \theta = \frac{(Q_2 - Q_1)^2}{25.2(d_3)^2} \cos \theta = 13.8$$

$$\text{Eq'n 4 } P_i = C_1 d_1^3 = 166.5 C_1$$

Hyd. Man.

Example Problem 3, continued

$$\text{Eq'n 5 } P_2 = C_2 d_2^3 = 53.5$$

$$\text{Eq'n 6 } P_i = 0$$

$$\text{Eq'n 7 } P_w = A_2 \bar{Y}_2 - A_1 \bar{Y}_1 + \frac{h^1}{2} (A_2 + A_1) + \frac{(h^1)^2}{12} (T_2 - T_1)$$

Term $\frac{(h^1)^2}{12} (T_2 - T_1)$insignificant and may be neglected.

$$\text{Eq'n 8 } P_f = \frac{L(S_1 + S_2)}{4} (A_1 + A_2)$$

$$P_2 + M_2 - M_3 \cos \theta = 119.3$$

By Trial and Error.....

D_1	D_1/d_1	M_1	P_1	P_w	$(-P_f)$	Σ
4.51	.82	59.5	43.0	14.8	-0.8	116.5
4.73	.86	57.2	47.7	15.2	-0.8	119.3

Check 



Therefore D_1 will be 4.73'

Example ProblemDetermination of Water Surface ProfileGiven:

"Q's", invert slopes, and conduit sizes for the various reaches as indicated on page F-19, and a downstream water surface control of 66.55 feet.

Solution:

Calculate the critical and normal depths for each reach in order to determine the correct direction of profile calculation. If D_c is greater than D_n , calculations should proceed downstream. If D_c is less than D_n , calculations should proceed upstream. The results are tabulated as follows:

Reach	Section	Q cfs	$D_c = (Q^2/b^2g)^{1/3}$ ft.	$K' = \frac{nQ}{b^{5/2}}$	D_n/b Table 7-11 King's	D_n ft.	Contr. Sta.	Direction of Calc.
1	 9'-0"W x 8'-6"H	622	5.30	0.498	0.75	6.75	0+00	Upstr.
2	"	"	"	0.201	0.38	3.42	4+96	Dwnstr.
3	"	"	"	0.469	0.71	6.39	"	Upstr.
4	"	609	5.22	0.459	0.70	6.30	5+46	Upstr.
5	 8'-9"W x 7'-0"H	"	5.32	0.775	1.07	9.36	11+34	Upstr.

The standard step method is used for determining open channel water surface profiles, and it is calculated by assuming a flow depth at the station where the flow depth is to be determined. The energy gradient at this station is calculated by two independent procedures as follows:

1. Add the assumed velocity head to the assumed flow depth.
2. Calculate the friction head loss based on the average friction slope between the stations under consideration. The energy gradient at the station where the flow depth is known should be increased or decreased by this head loss depending on the direction of profile calculation.

Example Problem Water Surface Profile continued.

The assumed flow depth is acceptable if a comparison of the energy gradients as computed above indicates a difference of 0.1 feet or less.

In Reach 3, D_n is greater than D_c , and therefore the profile calculation should proceed upstream from the control point at Station 4 + 96. (See page F-19.)

At Station 5 + 46 inflow occurs and a junction analysis must be performed in order to determine the control for Reach 4. This depth is calculated as follows (refer to page F-7, Case 2):

$$P_2 + M_2 = P_1 + M_1 + M_3 \cos \theta$$

$$\frac{b D_2^2}{2} + \frac{Q_2^2}{b D_2 g} = \frac{b D_1^2}{2} + \frac{Q_1^2}{b D_1 g} + \frac{Q_3^2}{A_3 g} \cos \theta$$

$$\frac{(9)(5.8)^2}{2} + \frac{(622)^2}{(9)(5.8)(32.2)} = \frac{9 D_1^2}{2} + \frac{(609)^2}{(9)(32.2) D_1} + \frac{(13)^2(.707)}{(6.28)(32.2)}$$

$$151.4 + 230.2 = 4.5 D_1^2 + \frac{1,279.8}{D_1} + 0.6$$

$$4.5 D_1^3 - 381.0 D_1 + 1,279.8 = 0$$

By trial and error, $D_1 = \underline{6.2}$ feet.

Tabled values of D_n and D_c indicate that the profile calculation should proceed upstream in Reaches 4 and 5. (See page F-21 for computations.) Since flow in the conduit becomes sealed somewhere in the curve in Reach 5, pressure flow is assumed for the length of the curve and the remainder of the reach, in lieu of a superelevated open channel water surface.

Example Problem Water Surface Profile continued.

In Reach 2, D_0 is less than D_c , and therefore the profile calculation should proceed downstream from the control point at Station 4 + 96. When critical depth is reached at Station 0 + 87, calculations are initiated at the next downstream control point which is the outlet. In Reach 1, D_0 is greater than D_c , and therefore the profile calculation should proceed upstream until critical depth is reached at Station 3 + 23. Between Stations 0 + 87 and 3 + 23, there are two alternate stages of flow and the necessary conditions to produce a hydraulic jump. The exact location of the jump is usually not required but can be determined by equating pressure plus momentum for upper and lower stages as indicated in the following diagram:

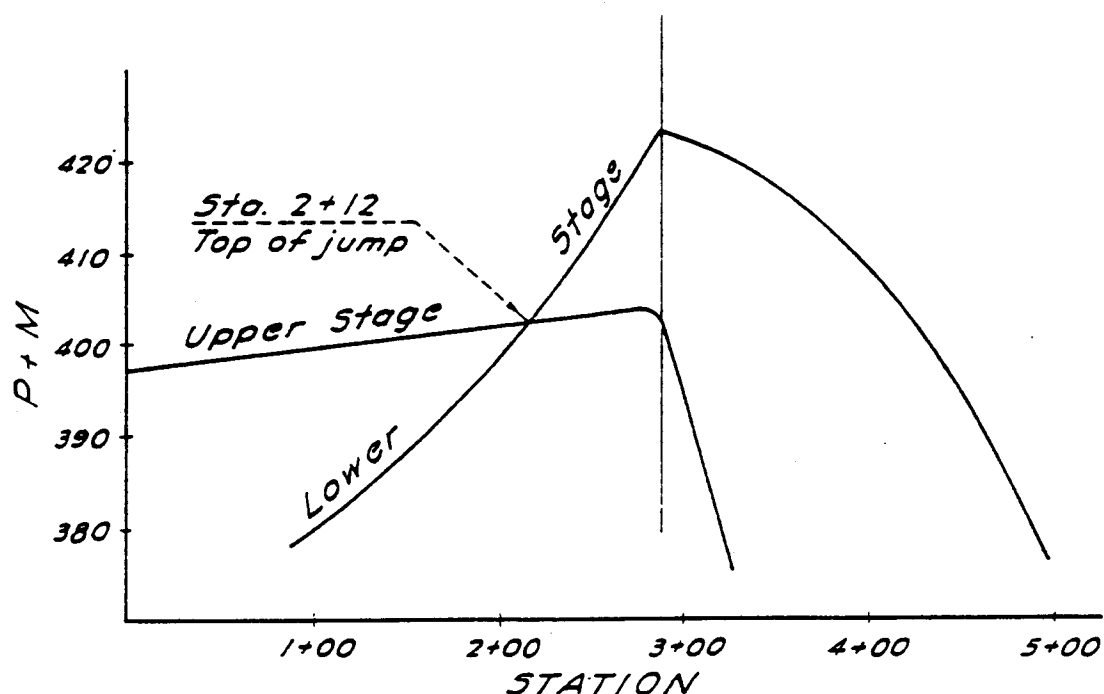

The location of the hydraulic jump also can be determined from a plot of sequent depths, Curve CB, superimposed upon the lower stage, AB, and the upper stage, DE, water surface profiles. The length of jump (L_j) as determined from Section F-1.2, is laid parallel to the channel invert to intersect the plot at F and the profile at G, locating the toe and the top of the jump, respectively. (See the diagram below.)

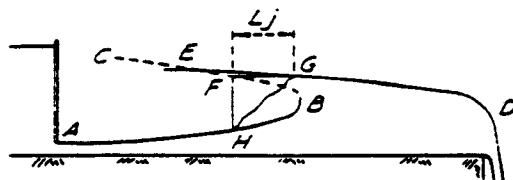

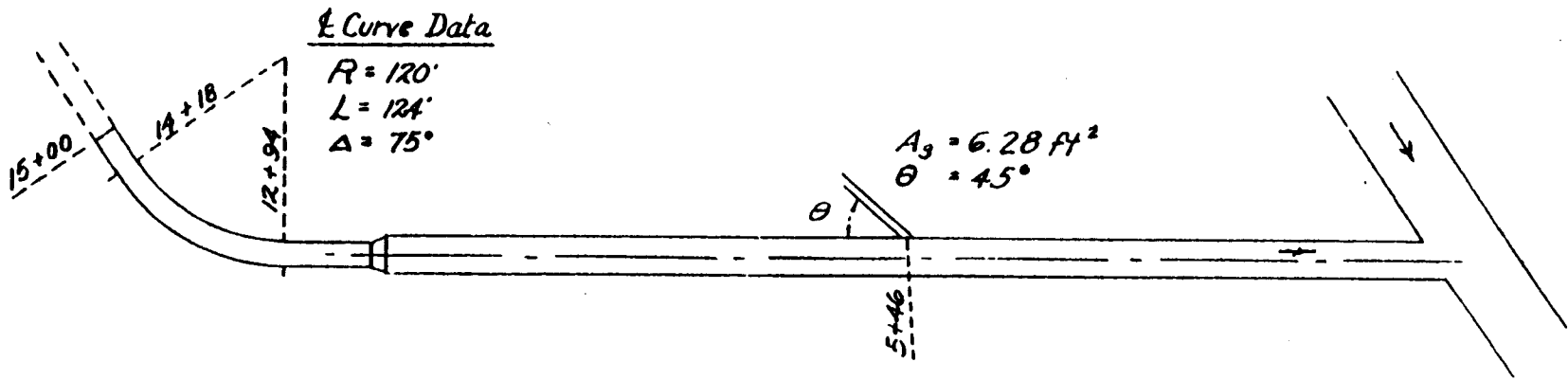
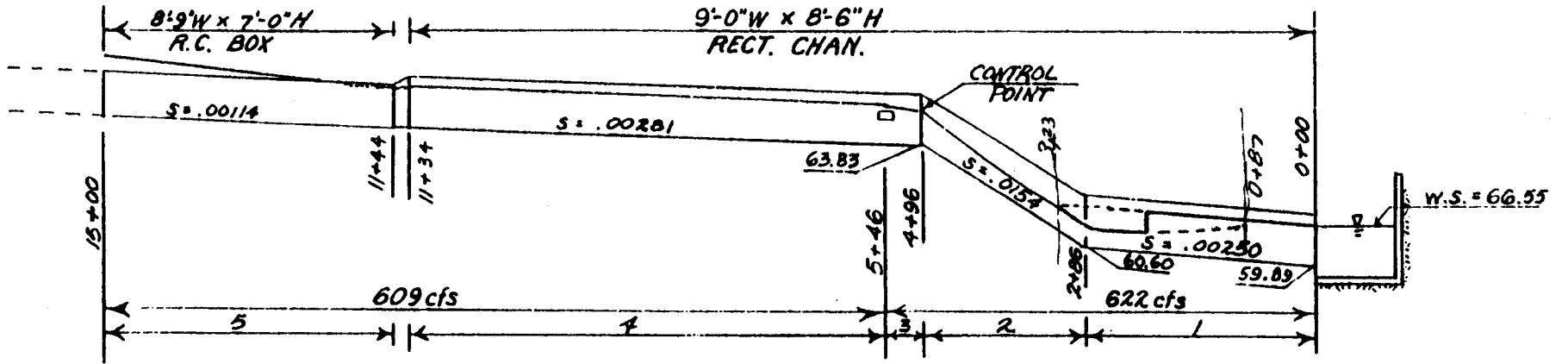

012	00420	020	01166
013	00492	022	01410
014	00571	025	01821
015	00656	030	02623
016	00746	035	03570

E.G. Elev. is obtained by adding (subtracting) h_f and h_i to (from) the center column E.G. Elev.

LOS ANGELES COUNTY FLOOD CONTROL DISTRICT Water Surface Computation Sheet					S=Channel Slope, E=D+Hv $S_f = \frac{2gn^2}{2.21} \frac{H_v}{R^{4/3}}$ or $\left[\frac{1}{K'}\right]^2 X^2$, $H_v = \frac{V^2}{2g}$, $L = \frac{\Delta E}{S - S_{fav}}$ $X = \frac{Qn}{b^{8/3}} = \frac{Qn}{d^{8/3}}$ $n = .014$ $\Delta E = L(S - S_{fav})$										Sheet _____ of _____ Calc. _____ Date _____ Check _____ Date _____ Ref. _____				
Station (L)	Invert Elev.	D	WS. Elev.	Q	Section	Area	V	Hv (ΔH_v)	E.G. Elev.	w.p. D/b	R (1/K') ²	R ^{4/3} X ²	S _f (S _{fav})	S	S - S _{fav}	E (ΔE)	h _f	h _i	E.G.* Elev.
4+96	63.83	5.30	69.13	622	9'-0" W x 8'-6" H	47.70	13.04	2.64	71.77	19.60	2.43	3.27	.00461						71.77
	3.00												.00499				0.02		
4+93	63.79	5.00	68.79	622	"	45.00	13.82	2.97	71.76	19.00	2.37	3.16	.00537						71.75
	52.00												.00696				0.36		
4+41	62.99	4.20	67.19	622	"	37.80	16.46	4.21	71.40	17.40	2.17	2.81	.00854						71.40
	155.00												.01030				1.60		
2+86	60.60	3.70	64.30	622	"	33.30	18.68	5.42	69.72	16.40	2.03	2.57	.01205						69.80
	93.00												.01030				0.96		
1+93	60.37	4.20	64.57	622	"	37.80	16.46	4.21	68.78	17.40	2.17	2.81	.00854						68.76
	65.00												.00743				0.48		
1+28	60.21	4.70	64.91	622	"	42.30	14.70	3.36	68.27	18.40	2.30	3.03	.00633						68.30
	29.00												.00585				0.17		
0+99	60.14	5.00	65.14	622	"	45.00	13.82	2.97	68.11	19.00	2.37	3.16	.00537						68.10
	12.00												.00499				0.06		
0+87	60.11	5.30	65.41	622	"	47.70	13.04	2.64	68.05	19.60	2.43	3.27	.00461						68.05
0+00	59.89	6.66	66.55	622	9'-0" W x 8'-6" H	59.94	10.38	1.67	68.22	22.32	2.68	3.73	.00256						68.33
	286.00												.00252				0.72		
2+86	60.60	6.75	67.35	622	"	60.75	10.24	1.63	68.98	22.50	2.70	3.76	.00248						68.94
	37.00												.00354				0.13		
3+23	61.17	5.30	66.47	622	"	47.60	13.04	2.64	69.11	19.60	2.43	3.27	.00461						69.11

n	$\frac{2gn^2}{2.21}$	n	$\frac{2gn^2}{2.21}$
012	00420	020	01166
013	00492	022	01410
014	00571	025	01821
015	00656	030	02623
016	00746	035	03570

LOS ANGELES COUNTY FLOOD CONTROL DISTRICT
Water Surface Computation Sheet

Project Example Problem
Reach _____

S = Channel Slope, E = D + H_v
 $S_f = \left[\frac{2gn^2}{2.21} \right] \frac{H_v}{R^{4/3}}$ or $\left[\frac{1}{K} \right]^2 X^2$, $H_v = \frac{V^2}{2g}$, $L = \frac{\Delta E}{S - S_{fav}}$
 $X = \frac{Qn}{b^{8/3}} = \frac{Qn}{dB^{8/3}}$ $n = .014$ $\Delta E = L(S - S_{fav})$

Sheet _____ of _____
 Calc. _____ Date _____
 Check _____ Date _____
 Ref. _____

Station (L)	Invert Elev	D	WS. Elev	Q	Section	Area	V	H _v (ΔH _v)	E.G. Elev.	w.p. D/b	R (1/K) ²	R ^{4/3} X ²	S _f (S _{fav})	S	S - S _{fav}	E (ΔE)	h _f	h _i	E.G.* Elev.
4+96 50.00	63.83	5.30	69.13	622	9'-0"W x 8'-6"H	47.70	13.04	2.64	71.77	19.60	2.43	3.27	.00461						71.77
5+46 P+M	63.97	5.80	69.77	622	"	52.20	11.92	2.21	71.98	20.60	2.53	3.45	.00365				0.21		71.98
5+46 550.00	"	6.20	70.17	609	"	55.80	10.91	1.85	72.02	21.40	2.61	3.59	.00295						72.02
10+96 38.00	65.52	6.50	71.82	609	"	56.70	10.74	1.79	73.61	21.60	2.62	3.62	.00283				1.59		73.61
11+34 10.00	65.62	6.32	71.94	609	"	56.88	10.71	1.78	73.72	21.64	2.63	3.63	.00280				0.11		73.72
11+44 n = .013	65.65	6.16	71.81	609	8'-9"W x 7'-0"H	53.9	11.30	1.98	73.79	21.07	2.56	3.50	.00302				0.03	0.04	73.79
11+44 150.00	65.65	6.16	71.81	609	"	53.9	11.30	1.98	73.79	21.07	2.56	3.50	.00279						73.79
12+94 100.00	65.62	6.65	72.47	609	"	58.19	10.47	1.70	74.17	22.05	2.64	3.65	.00230				0.38		74.17
13+94	65.93	6.85	72.78	609	"	59.34	10.16	1.60	74.38	22.45	2.67	3.70	.00213				0.22		74.39

Hyd. Man.	STA.	ELEV. INV.	D	ELEV. W.S.	SECTION	A*	K*	Q	V	$\frac{v^2}{2g}$	E.G.	S _f	Av. S _f	L	h _f	h _b	h _j	h _t	E.G.	
	12+94	65.82	7.00	72.82	8'-9"W x 7'-0"H	60.63	11,110	609	10.04	1.57	74.39	.00300								74.39
	14+18	65.96	7.52	73.48	"	"	"	"	"	"	75.05	"	.00300	124.00	0.37	0.29			75.05	
	15+00	66.05	7.68	73.73	"	"	"	"	"	"	75.30	"	"	82.00	0.25				75.80	

* Value given in "Hydraulics Properties of Boxes" tables, assuming $K = ACVR$.

Example ProblemDesign of Straight Contraction

Design a straight contraction connecting two rectangular channels 12 feet and 6 feet wide, respectively. The discharge through the contraction is 200 cfs and the depth of the approach flow is 0.70 feet. Refer to Chart C-20.

$$A_1 = 12 \times 0.70 = 8.4 \text{ feet}^2$$

$$V_1 = Q/A_1 = 200/8.4 = 23.8 \text{ f.p.s.}$$

$$F_1 = V_1 / \sqrt{gd_1} = 23.8 / \sqrt{32.2 \times 0.7} = 5.01$$

Arbitrarily selecting a depth ratio $d_3/d_1 = 2$, the continuity equation will give $F_3 = 3.54$. This value should be considerably greater than 1.0.

Estimating $\theta = 15^\circ$, and given $F_1 = 5.01$, Chart C-20 indicates that

$$F_2 = 2.8 \text{ and } d_2/d_1 = 2.6.$$

By analogy, where $F_1 : F_2$ as $F_2 : F_3$ and $d_2/d_1 : d_3/d_2$, Chart C-20 indicates that for the same θ and $F_2=2.8$, $F_3=1.77$ and $d_3/d_2=1.8$.

However, $d_3/d_1 = (d_2/d_1) (d_3/d_2) = 2.6 \times 1.8 = 4.68$, which does not agree with the assumed value of 2.

After several trials, $\theta = 5^\circ$. For this angle and $F_1 = 5.01$, the diagram gives $d_2/d_1 = 1.35$ and $d_3/d_2 = 1.50$.

$$d_3/d_1 = 1.35 \times 1.50 = 2.03$$

$$d_3 = 2.03 \times 0.70 = \underline{1.42 \text{ ft.}}$$

$$L = \frac{B_1 - B_3}{2 \tan \theta} = \frac{12 - 6}{2 \tan 5^\circ} = \underline{34.3 \text{ ft.}}$$

Example ProblemMaximum Depth for Channel With Break in Slope

The problem is to determine the maximum depth of water in a channel due to a break in slope. Refer to Charts C-30, C-31 and C-32.

Given:

Upstream reach: $L=2400$ ft., $S_0=0.10$, $F=5.6$, $D_n=1.0$ ft.

Downstream reach: $L=3350$ ft., $S_0=.0392$, $F=3.5$, $D_n=1.37$ ft.

$$(h_{\max})_{\max} = \text{Maximum value of } h_{\max} = \bar{h}_{\max} + 2.58 \sigma h_{\max}$$

Method 1

At the downstream end of the $S_0 = .10$ reach:

$$L/D_n = 2400, \bar{h}_{\max}/D_n = 1.6, \bar{h}_{\max} = 1.6 \text{ ft.}$$

$$\sigma h_{\max}/D_n = .18, (h_{\max})_{\max} = 1.6 + 2.58(0.18) = 2.06 \text{ ft.}$$

At the upstream end of the $S_0 = .0392$ reach:

$$\bar{h}_{\max}/D_n = 1.6/1.37 = 1.17, \text{ which corresponds to } L/D_n = 2500$$

$$\sigma h_{\max}/D_n = .18/1.37 = .13, \text{ which corresponds to } L/D_n = 3600$$

At the downstream end of the $S_0 = .0392$ reach:

$$\text{for } \bar{h}_{\max}: L/D_n = 2500 + 2440 = 4940, \bar{h}_{\max}/D_n = 1.58,$$

$$\bar{h}_{\max} = 1.58 \times 1.37 = 2.16 \text{ ft.}$$

$$\text{for } \sigma h_{\max}: L/D_n = 3600 + 2440 = 6040, \sigma h_{\max}/D_n = .20,$$

$$\sigma h_{\max} = .20(1.37) = 0.27 \text{ ft.}$$

$$(h_{\max})_{\max} = \underline{2.37 \text{ ft.}}$$

Example Problem Maximum Depth continued.

Method 2

$$\text{Average } S_o = \frac{2400}{5750} \times .10 + \frac{3350}{5750} \times .0392 = .0645$$

$$\text{Equivalent } D_n = (0.10/.0645)^{1/3} \times 1.0 = 1.16 \text{ ft.}$$

$$\text{Equivalent } F = (.0645/.10)^{1/2} \times 5.6 = 4.5$$

Therefore, use curves for $S_o = .08429$

$$L/D_n = 5750/1.16 = 4950, \bar{h}_{\max}/D_n = 2.06,$$

$$\bar{h}_{\max} = 1.16 \times 2.06 = 2.39 \text{ ft.}, \sigma_{h_{\max}}/D_n = .27,$$

$$\sigma_{h_{\max}} = 1.16 \times .27 = .31 \text{ ft.}$$

$$(h_{\max})_{\max} = \underline{3.20 \text{ ft.}}$$

Method 3

$$L = 5750 \text{ ft.}, F = 5.6, D_n = 1.0 \text{ ft.}$$

$$L/D_n = 5750, \bar{h}_{\max}/D_n = 2.55, \bar{h}_{\max} = 2.55 \text{ ft.}$$

$$\sigma_{h_{\max}}/D_n = .36, (h_{\max})_{\max} = 3.48 \text{ ft.}$$

$$L = 5750 \text{ ft.}, F = 3.5, D_n = 1.37 \text{ ft.}$$

$$L/D_n = 5750/1.37 = 4200, \bar{h}_{\max}/D_n = 1.48,$$

$$\bar{h}_{\max} = 2.03 \text{ ft.}, \sigma_{h_{\max}}/D_n = .155, \sigma_{h_{\max}} = .21,$$

$$(h_{\max})_{\max} = 2.58 \text{ ft.}$$

Weighted averages:

$$\bar{h}_{\max} = \frac{2400}{5750} \times 2.55 + \frac{3350}{5750} \times 2.03 = 2.24 \text{ ft.}$$

$$(h_{\max})_{\max} = \frac{2400}{5750} \times 3.48 + \frac{3350}{5750} \times 2.58 = \underline{2.95 \text{ ft.}}$$

Example Problem
Side Channel Spillway Inlet

Side Channel (Given Data)

$$Q = 700 \text{ c.f.s.} \quad \text{Rect. Chan. } b = 10' \quad \text{Slope} = .0900 \quad d = 3.12'$$

Main Channel (Given Data)

$$S_f = .01656$$

Spillway Length

$$L = \frac{Q}{CH^{3/2}} \quad CH^{3/2} = (3.087)(1.5)^{3/2} = 5.7 \quad \text{Use } 5 \text{ c.f.s./ft.}$$

$$L = \frac{700 \text{ c.f.s.}}{5 \text{ c.f.s./ft.}} = 140' \quad \text{Try } L = 150' \text{ to assure discharge of total } Q$$

Spillway Wall Height

$$\begin{aligned} \text{depth of flow, } d &= 3.12' \\ \text{Max. head on spillway, } H &= 1.50' \end{aligned}$$

$$\text{Wall ht.} = 3.12' - 1.50' = 1.62'$$

Determination of Spillway Channel Widths

Using the spillway length determined above, the overflow spillway is laid out (see page F-26) using widths determined by trial. Upon completing the layout, the spillway widths at 20-foot intervals are taken from the drawing and the outflow is checked.

See computation on page F-27.

(Note all trials necessary to obtain the desired widths are not shown on the sample problem.)

Hyd. Man.

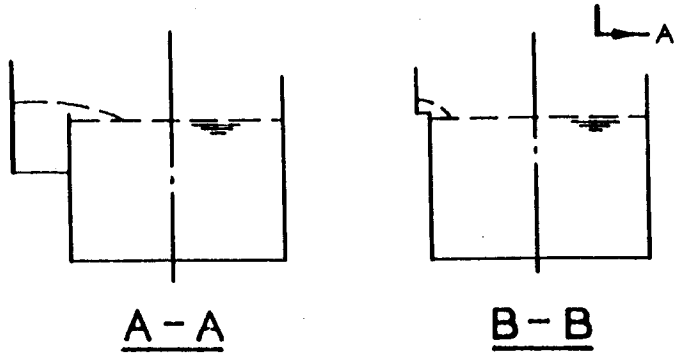
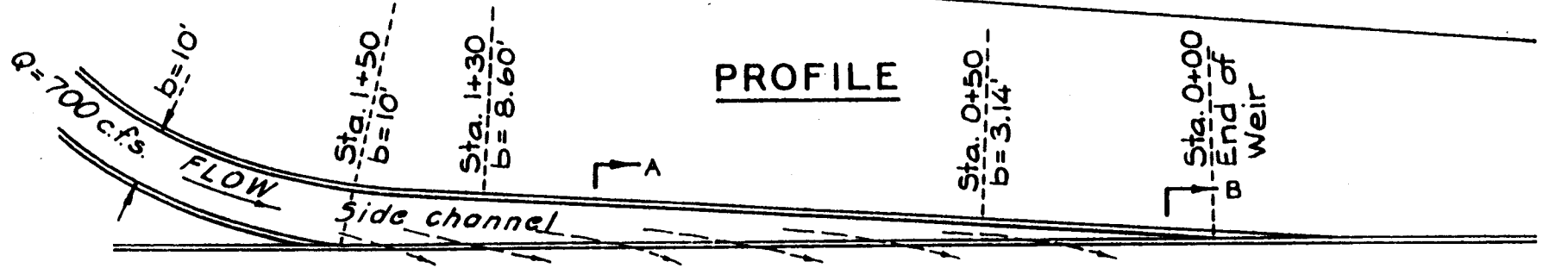
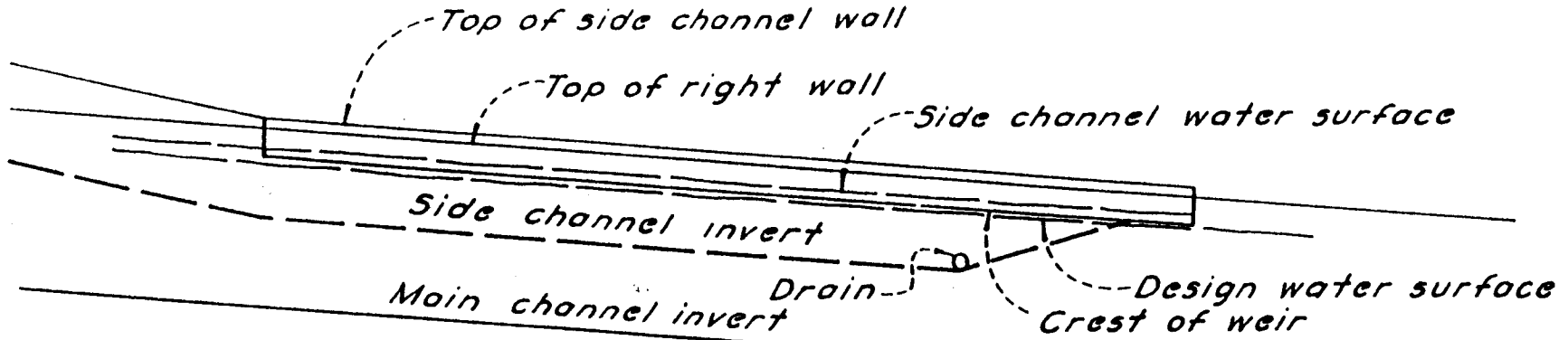

PLAN

TYPICAL SIDE CHANNEL INLET

SIDE CHANNEL SPILLWAY INLET CALCULATION SHEET

Q = 700

n = .014

$S_0 =$ INVERT SLOPE

$$S_f = \left(\frac{Q_2 n}{1.486 A R^{2/3}} \right)^2$$

d = DEPTH OF FLOW IN SIDE CHANNEL

$$\Delta E = \Delta L (S_0 - S_f)$$

$$E.G. = d + \frac{V^2}{2g}$$

$H_w =$ HEAD ON WEIR

PROJECT SAMPLE PROBLEM

CALCULATED BY GJP

DATE 6-1-73

STATION	SECTION	d	A	$\frac{V^2}{2g}$	E.G.	W.P.	R ^{2/3}	S _f	S ₀	S ₀ - S _f	ΔL	ΔE	CHECK E.G.	H _w	FLOW OUT Q ₁ = CAL H _w ^{3/2}	DESIRED Q ₂	Q ₃ ±	ACTUAL Q ₄
									.0900									
1+50	b=10'	3.12	31.2	7.80	10.92	16.24		.01880										
1+50	b=10' 1.62'	3.12	31.2	7.80	10.92	14.74	1.65	.01644								700		
								.01707	.01656	-.00051	20	-.01				700		
1+30	b=8.6' 1.62'	3.12	26.85	7.78	10.90	13.34	1.59	.0177						1.50	114			700
								.01401	.01636	-.00235	20	-.05				600	+14	586
1+10	b=7.14' 1.62'	3.05	21.80	7.80	10.85	11.01	2.50	.01032						1.43	106			
								.01691	.01656	-.00035	20	-.01				486	+6	480
0+90	b=5.78' 1.62'	2.92	16.85	7.93	10.85	10.32	1.39	.02350						1.30	92			
								.02530	.01656	-.00874	20	-.18				380	-8	388
0+70	b=4.45' 1.62'	2.90	12.90	7.75	10.65	8.57	1.28	.02710						1.28	90			
								.03045	.01656	-.01388	20	-.38				288	-10	298
0+50	b=3.14' 1.62'	2.89	9.06	7.46	10.35	7.65	1.12	.0338						1.27	89			
																198	-11	209
0+00	END OF WEIR								-.01940					1.27	221			
																0		0

$Q = (3.087)(50)(1.27)^{3/2}$

Q₁ = FLOW OUT OF SIDE CHANNEL

Q₂ = DESIRED FLOW IN SIDE CHANNEL

Q₃ = DIFFERENCE BETWEEN ACTUAL AND DESIRED FLOW IN SIDE CHANNEL

Q₄ = ACTUAL FLOW IN SIDE CHANNEL

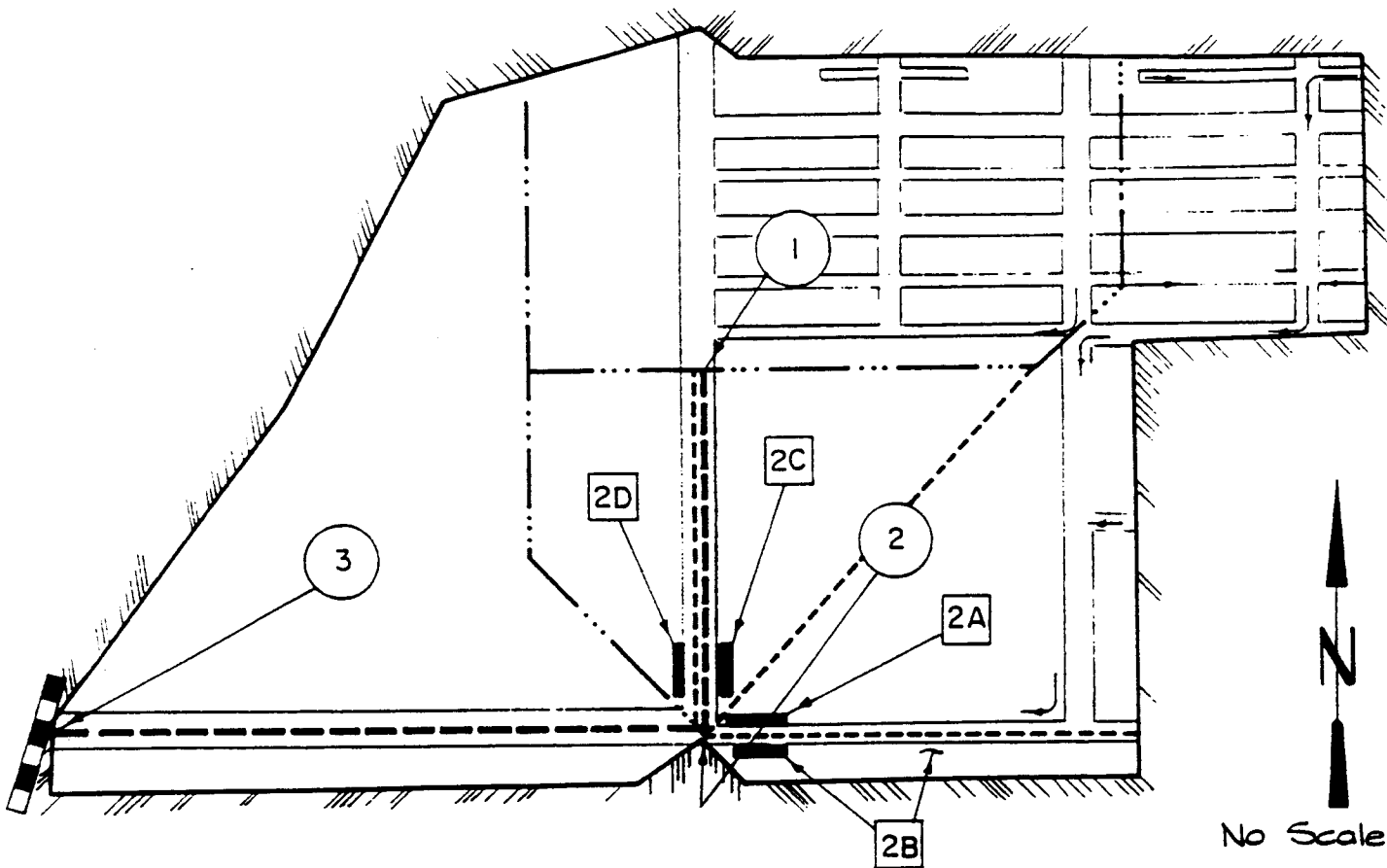

LEGEND

- Major Drainage Area Boundary
- Mainline Sub-Drainage Area Boundaries
- Catch Basin Sub-Drainage Area Boundaries
- Flow Path
- Mainline
- Outlet
- Catch Basins
- Mainline Sub-Drainage Area Numbers
- Catch Basin Sub-Drainage Area Numbers

MAINLINE HYDROLOGY DATA **				
Reach or Sub-Area	Area (Acres)		Q (c.f.s.)	
	Sub-Area	Total	Sub-Area (Q _p)	Reach
①	45		70	
①-②		45		70
②	70		105	
②-③		115		160
③	50		75	
③-Outlet		165		220

** Provided by L.A.C.F.C.D. Hydraulic Div.

CATCH BASIN HYDROLOGY *

For Mainline Sub Drainage Area No. 2

$A_T = 70 \text{ Acres}$ $Q_p = 105 \text{ c.f.s.}$ $Q_p/A_T = \frac{1.5 \text{ c.f.s.}}{\text{Acre}}$

C.B. Sub Drain Area #	A (Acres)	Q _p /A _T (c.f.s./Acre)	Q _{des} (c.f.s.)
2A	40	1.5	= 60
2B	5	1.5	= 7.5
2C	15	1.5	= 22.5
2D	10	1.5	= 15

$Q_{des} = \frac{Q_p}{A_T} A$

Los Angeles County
Flood Control District
EXAMPLE CATCH BASIN HYDROLOGY PROBLEM

* See D-1

LEVEE CRITERIA

The following criteria is for the design of levee linings placed in or adjacent to natural watercourses that are to be approved or maintained by the District. The designer is given the choice of a number of materials to provide flexible or rigid linings. It is up to the designer to determine the most appropriate and economical material for his particular location.

Flow Velocities

The anticipated maximum flow velocity restricts the type of material that can be used and determines the structural requirements of the lining. The designer is required to submit engineering calculations which show the maximum expected flow velocity attacking or flowing adjacent to the levee. This velocity is used to determine the cutoff depth, levee thickness, and rock size.

The following criteria permits the design of a levee lining of certain materials up to a flow velocity of 20 fps. If conditions exist where the velocity would exceed 20 fps, measures will have to be taken, such as the construction of drop structures in the natural watercourse, to reduce the velocity.

Levee Cutoff Depths

All levee linings must extend below the grade of the natural watercourse to the depth indicated in the table for cutoff depths of this criteria. The only exception to this will be in the case of rock rip-rap and gabion lining where an apron can be provided that can adjust to scour conditions.

Lining Returns

It is required that the upstream and downstream terminus of the levee connect to the natural bank or adjoining levee improvements with transitions designed to ease differentials in alignment, grade, slope, and roughness of banks. The criteria for the depth of cut-off for the levee also apply to the transition section. If the proposed lining does not join an existing lining that meets this criteria, the proposed lining must be returned into the natural bank at an angle of 30 degrees, a perpendicular distance of not less than four feet, or in lieu thereof a four-foot cutoff wall.

LEEVE CRITERIA

Filter Blankets and Weep Holes

Filter blankets will be required under all rock rip-rap and gabion levee linings. Weep holes connected by continuous drainage material are required for all concrete and gunite levee linings. Weep holes are also required if grouted rip-rap is used.

Scour Gages

Scour gages are required in conjunction with all levee construction. The gages will be used to determine actual scour patterns for future refinement of the levee criteria. Unless otherwise directed, scour gages shall be 12-inch diameter holes, 20-feet deep, filled with 1/2-inch to 1-1/2-inch diameter stone, that has a color distinctly different from the surrounding material. The gages shall be placed in sets of (3) beginning at the toe of the levee and spaced at 50-feet perpendicular from the levee out into the watercourse.

The sets of three gages shall be spaced every 1,000 feet longitudinal to the levee. A minimum of 2 sets (gages) are required for each levee constructed. The exact location of the gages shall be shown on the project drawings, with the instruction to the Contractor to determine the elevation of the top of the gage upon completion of construction and make record of such for the as built drawings.

The tables on the following pages (F-32 to F-34) contain the criteria for cutoff depths, material and structural requirements, rock gradation, and filter design.

Typical levee cross-sections are shown on Pages F-35 and F-36. A typical cross-section at a scour gage is shown on Page F-37.

LEVEE CRITERIA

Cut-Off Depths

Velocities	Straight Reaches	*Curved Reach
0 - 6 f.p.s.	6-ft.	9-ft.
6 - 10 f.p.s.	8-ft.	12-ft.
10 - 15 f.p.s.	10-ft.	15-ft.
15 - 18 f.p.s.	12.5 ft.	18-ft.
18 - 20 f.p.s.	14 ft.	21-ft.

*Check the cut off depth for curved reach on Chart F-06 on Page F-38
Use that depth if greater than given hereon.

Material and Structural Requirements

Concrete Levees (1 1/2:1 max. side slope)

Velocities	Levee Thickness - T		Reinforcing
	Straight Reach	Curved Reach	
0 - 10 f.p.s.	6-inch	8-inch	#4 @ 18" Bothways
10 - 20 f.p.s.	8-inch	10-inch	#4 @ 18" Bothways

Gunite Levees (1 1/2:1 max. side slopes)

Velocities	Levee Thickness - T		Reinforcing
	Straight Reach	Curved Reach	
0 - 10 f.p.s.	8-inch	10-inch	#4 @ 18" Bothways

Gunite levees not permitted where velocities exceed 10 f.p.s.

Material and Structural Requirements

Rip-Rap Levees (2:1 max. side slopes)

(Ungroued)

Velocities	Rock Size (D50 Size)	Levee Thickness - T		Filter Thickness
		Straight Reach	Curved Reach	
0 - 7 f.p.s.	50 lb. (10")	15-inch	20-inch	6-inch
7 - 9 f.p.s.	100 lb. (12")	18-inch	24-inch	6-inch
10 f.p.s.	150 lb. (15")	23-inch	30-inch	9-inch
11 f.p.s.	300 lb. (18")	27-inch	36-inch	9-inch
12 f.p.s.	1/4-ton (21")	32-inch	42-inch	9-inch
13 f.p.s.	1/2-ton (27")	41-inch	54-inch	12-inch
13 - 15 f.p.s.	1-ton (34")	51-inch	68-inch	12-inch
16 - 17 ⁵ f.p.s.	2-ton (43")	65-inch	86-inch	12-inch
18 - 20 f.p.s.	4-ton (54")	81-inch	108-inch	12-inch
(Grouted) Can be used only with special District approval				
16 - 20 f.p.s.	1-ton (34")	51-inch	68-inch	12-inch

Gabion Levees (2:1 side slopes)

Velocities	Levee Thickness (Straight or Curved Reach)	Rockfill	Wire Gage of Baskets	Apron Length
0 - 7 f.p.s.	12-inch Baskets	4" - 8"	12 ga.	12 feet
8 - 10 f.p.s.	18-inch Baskets	4" - 8"	11 ga.	18 feet
11 - 15 f.p.s.	18-inch Baskets	4" - 8"	11 ga.	21 feet

Gabion levees not permitted where velocities exceed 15 f.p.s.

LEVEE CRITERIA

Material and Structural Requirements

Rock Rip-Rap Gradation

Rock Sizes (Percentage Larger Than)	D50								
	4 Ton	2 Ton	1 Ton	1/2 Ton	1/4 Ton	300#	150#	100#	50#
8 Ton	0-5								
4 Ton	50-100	0-5							
2 Ton	35-100	50-100	0-5						
1 Ton		95-100	50-100	0-5					
1/2 Ton			95-100	50-100	0-5				
1/4 Ton				95-100	50-100	0-5			
300#						50-100	0-5		
200#					95-100			0-5	
150#						95-100	50-100		
100#								50-100	0-5
75#							95-100		
50#								95-100	50-100
25#									95-100

Filter Material

The following criteria is to be met when selecting the filter blanket material:

$$\frac{D_{15} \text{ filter}}{D_{85} \text{ base}} < 5 < \frac{D_{15} \text{ filter}}{D_{15} \text{ base}} < 40 > \frac{D_{50} \text{ filter}}{D_{50} \text{ base}}$$

$$\text{and} \quad \frac{D_{15} \text{ rip rap}}{D_{85} \text{ filter}} < 5 < \frac{D_{15} \text{ rip rap}}{D_{15} \text{ filter}} < 40 > \frac{D_{50} \text{ rip rap}}{D_{50} \text{ filter}}$$

Base refers to the material underlying the filter, the natural bank material.

D15 for example refers to the 15 per cent size of the material and so forth for the other values; D50 and D85.

TYPICAL GUNITE OR CONCRETE LEVEE SECTION

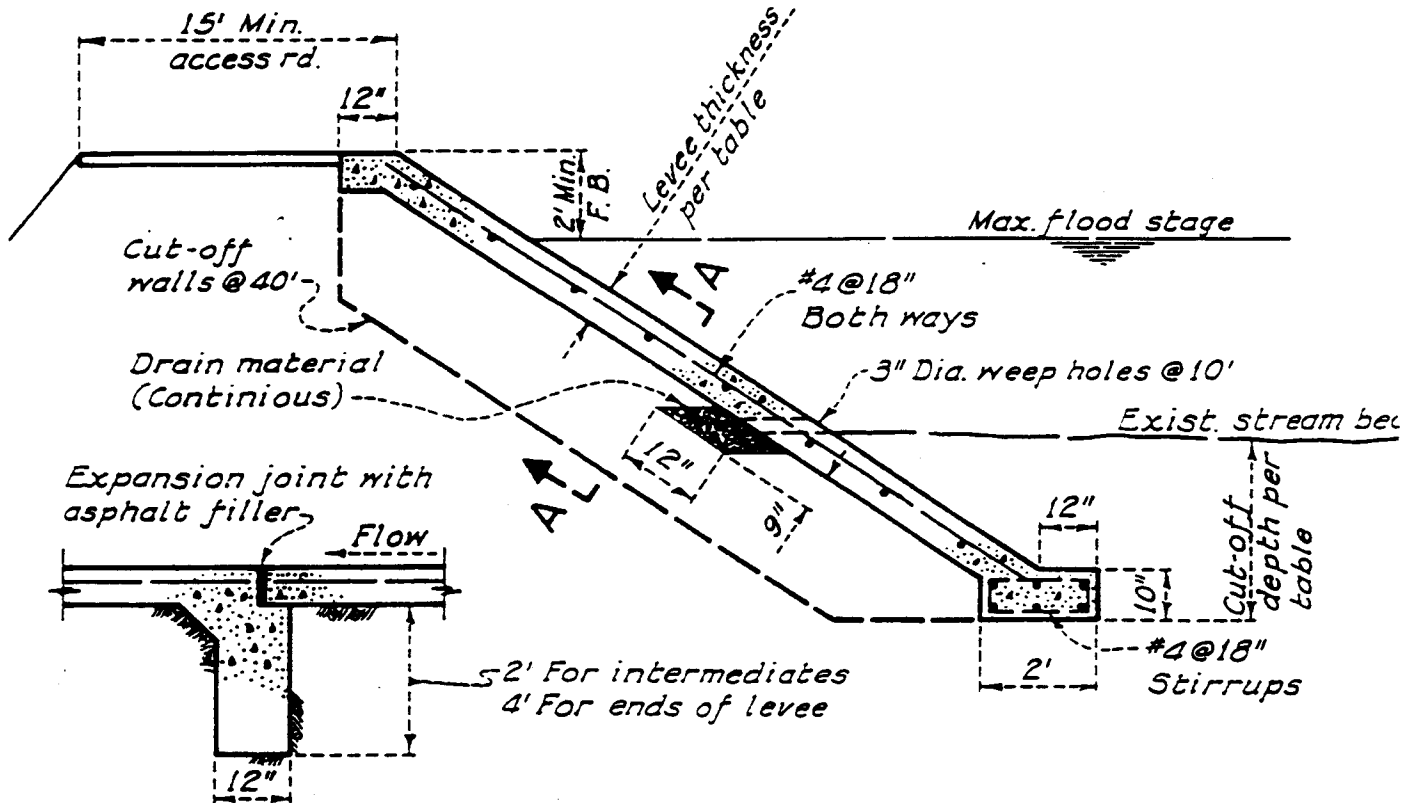

SECTION A-A

TYPICAL GABION LEVEE SECTION

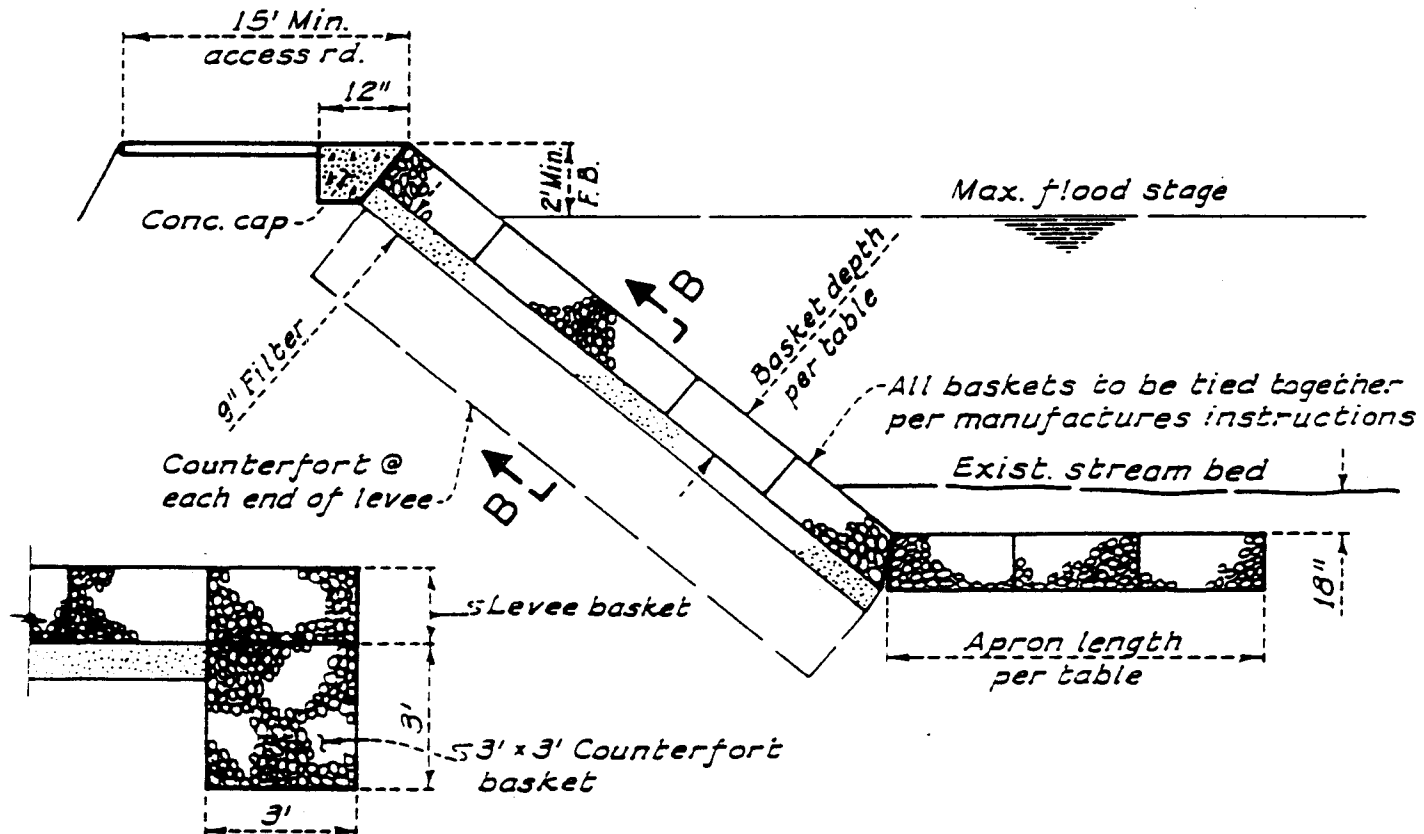

SECTION B-B

TYPICAL ROCK RIP-RAP LEVEE SECTIONS

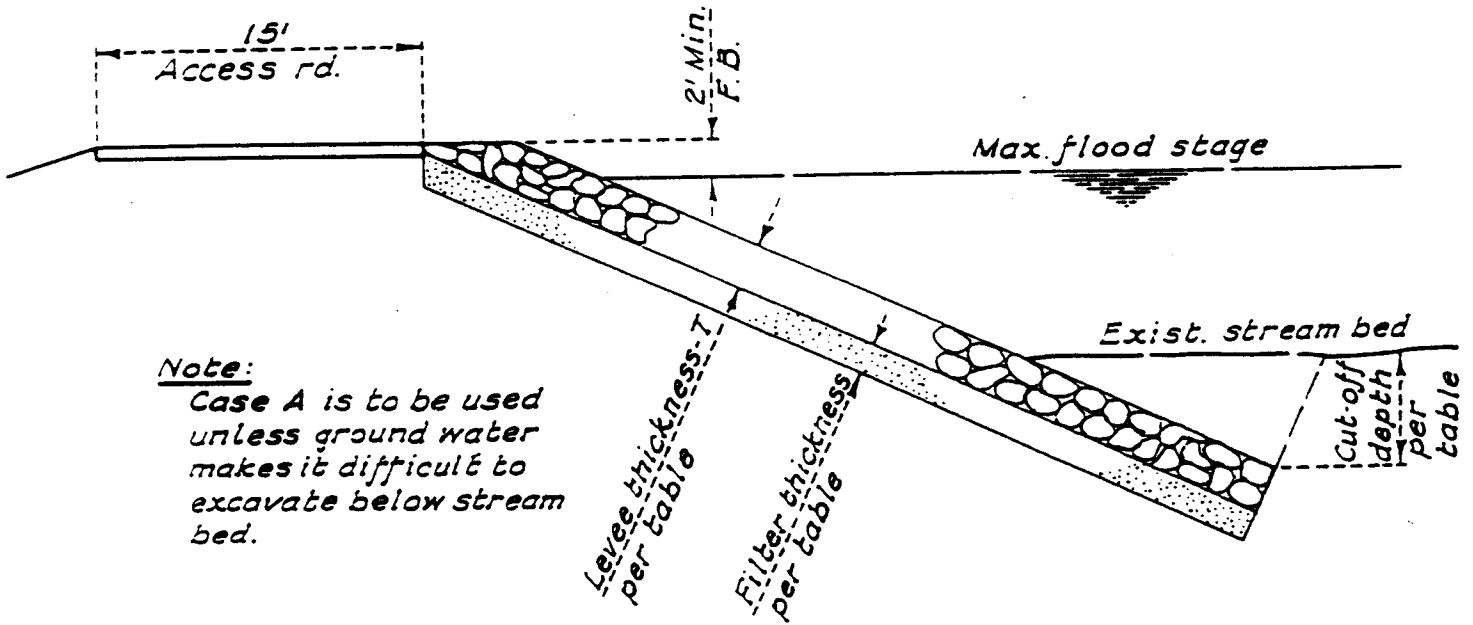

Note:
 Case A is to be used unless ground water makes it difficult to excavate below stream bed.

CASE A

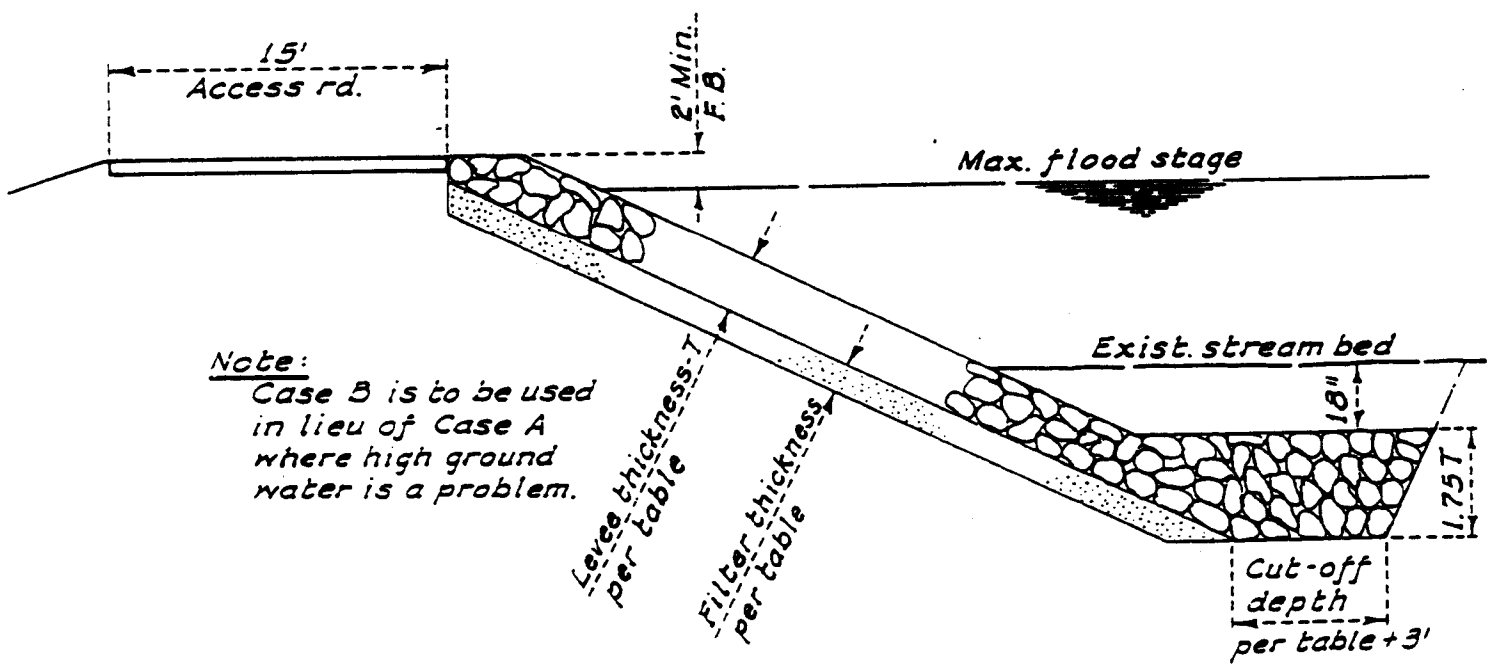

Note:
 Case B is to be used in lieu of Case A where high ground water is a problem.

CASE B

TYPICAL SECTION AT SCOUR GAGES

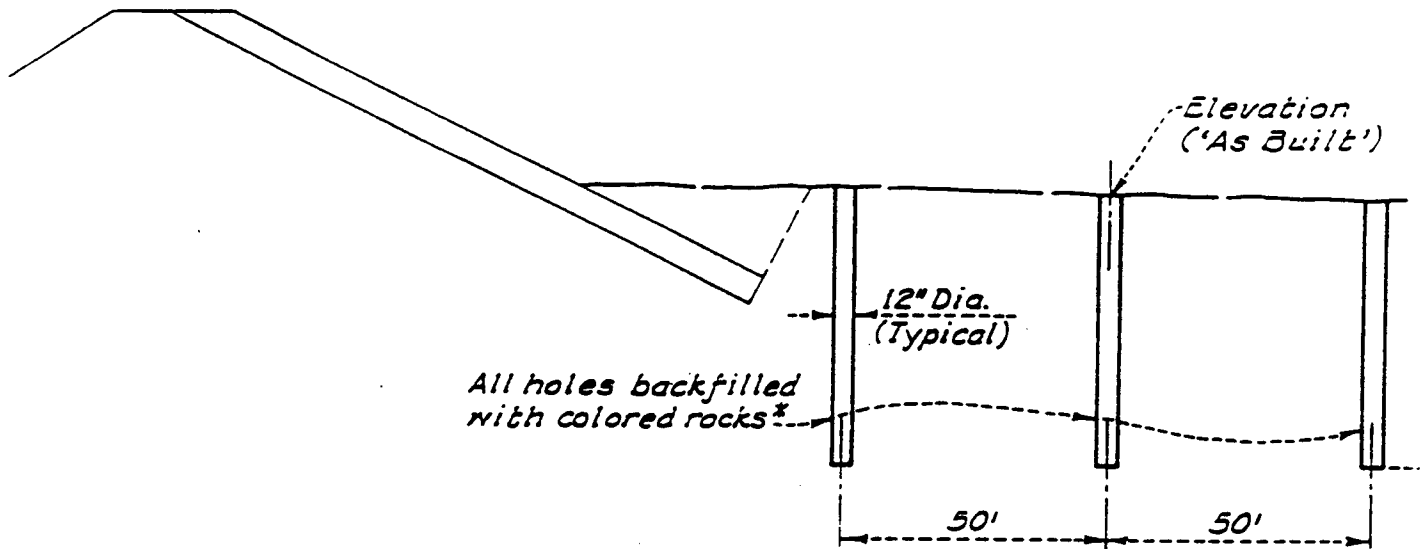

** Rock to be 1/2" - 1 1/2" with a color that is distinctly different than the surrounding material.*

The 'As Built' Elevation of the top of each scour gage is to be accurately surveyed and recorded on the 'As Built' drawings.

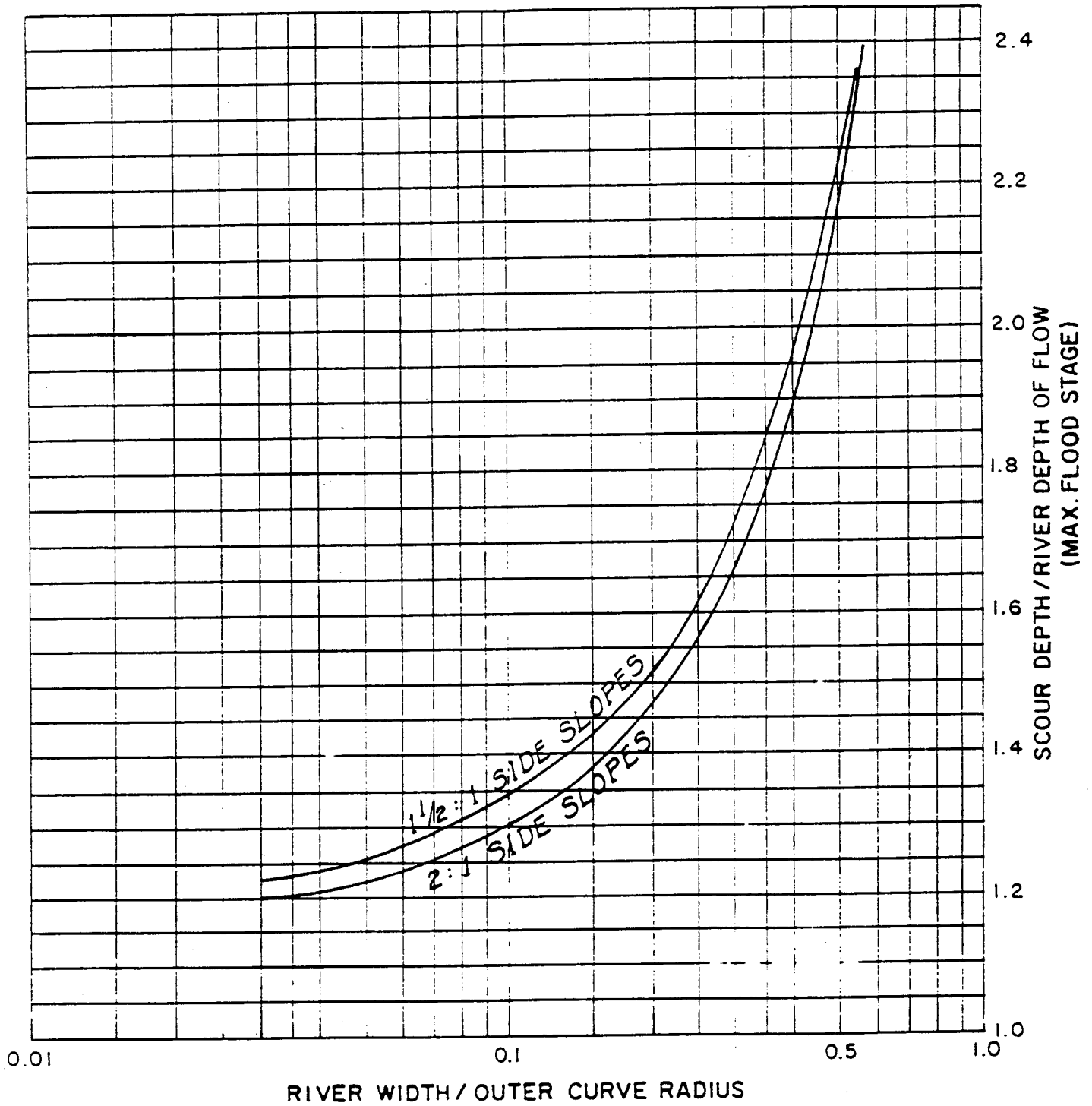

SCOUR DEPTHS ON OUTER CURVES

HYDRAULIC GRADE LINE CALCULATION SHEET

PROJECT _____
LINE _____

Los Angeles County Flood Control District

CALCULATED BY _____

*Conduit unseals when D is less than d

DATE _____

STA.	ELEV. INV.	D *	ELEV. H.G.L.	SEC-TION	d	A	Q	V	$\frac{v^2}{2g}$	K	S _f	Av. S _f	L	h _f	h _b	h _j	h _t	ELEV. E.G.L.

B - 01

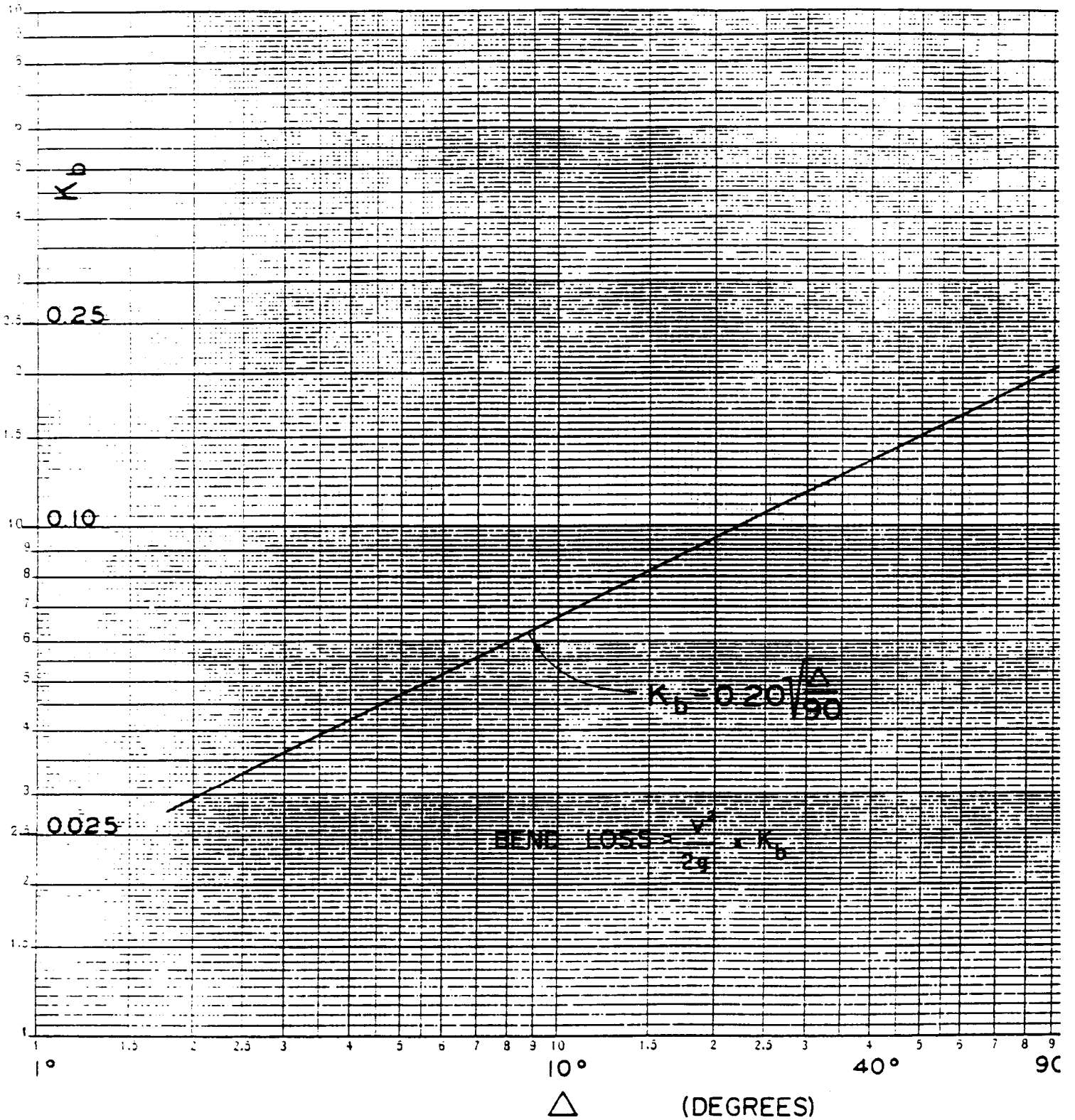

BEND LOSSES

Los Angeles County Flood Control District

FACTORS FOR CLOSED CONDUITS FLOWING FULL

Manning's Formula ; $Q = \frac{1.486}{n} A R^{\frac{2}{3}} s^{\frac{1}{2}}$

$K = \frac{Q}{s^{\frac{1}{2}}} = \frac{1.486 A R^{\frac{2}{3}}}{0.013}$ for pipe $K = 35.6259 \frac{d^{\frac{8}{3}}}{s^{\frac{1}{2}}}$
 for box $K = 114.3077 \frac{A^{\frac{2}{3}}}{p^{\frac{1}{2}}}$

$Q = K s^{\frac{1}{2}}$

$s = \left(\frac{Q}{K}\right)^2$

- Where: Q = discharge in cfs
 s = friction slope
 A = area of conduit
 R = hydraulic radius of conduit
 n = 0.013
 d = diameter of pipe
 " = height of equivalent box
 w = width of equivalent box
 p = wetted perimeter

PIPE & BOX		PIPE		EQUIVALENT BOX			
d		A	K	w		A	K
ft.	in.	sq. ft.		ft.-in.	ft.	sq. ft.	
1.25	15	1.227	64.6				
.50	18	1.767	105.0				
.75	21	2.405	158.4				
2.00	24	3.142	226.2				
.25	27	3.976	309.7				
.50	30	4.909	410.1				
.75	33	5.939	528.7				
3.00	36	7.068	666.9				
.25	39	8.295	825.8				
.50	42	9.621	1,006				
.75	45	11.047	1,209				
4.00	48	12.566	1,436				
.25	51	14.186	1,688				
.50	54	15.901	1,967				
.75	57	17.721	2,272				
5.00	60	19.635	2,604				
.25	63	21.648	2,966				
.50	66	23.758	3,358				
.75	69	25.967	3,780				
6.00	72	28.274	4,236				
.25	75	30.680	4,720				
.50	78	33.183	5,244				
.75	81	35.785	5,796				
7.00	84	38.485	6,388	5'-10"	5.83	40.3	6,357
.25	87	41.283	7,015				
.50	90	44.179	7,677	6'-2"	6.33	47.0	7,780
.75	93	47.173	8,379				
8.00	96	50.266	9,120	6'-9"	6.75	53.5	9,256
.50	102	56.745	10,720	7'-2"	7.08	59.7	10,635
9.00	108	63.617	12,437	7'-6"	7.50	67.0	12,452
.50	114	70.882	14,221	8'-0"	8.00	75.4	14,598
10.00	120	78.540	16,098	8'-5"	8.42	83.6	16,726
.50	126	86.590	18,035	8'-10"	8.83	92.1	19,026
11.00	132	95.033	20,022	9'-2"	9.17	100.3	21,503
.50	138	103.879	22,065	9'-7"	9.58	109.5	23,952
12.00	144	113.098	24,260	10'-0"	10.00	119.2	26,529

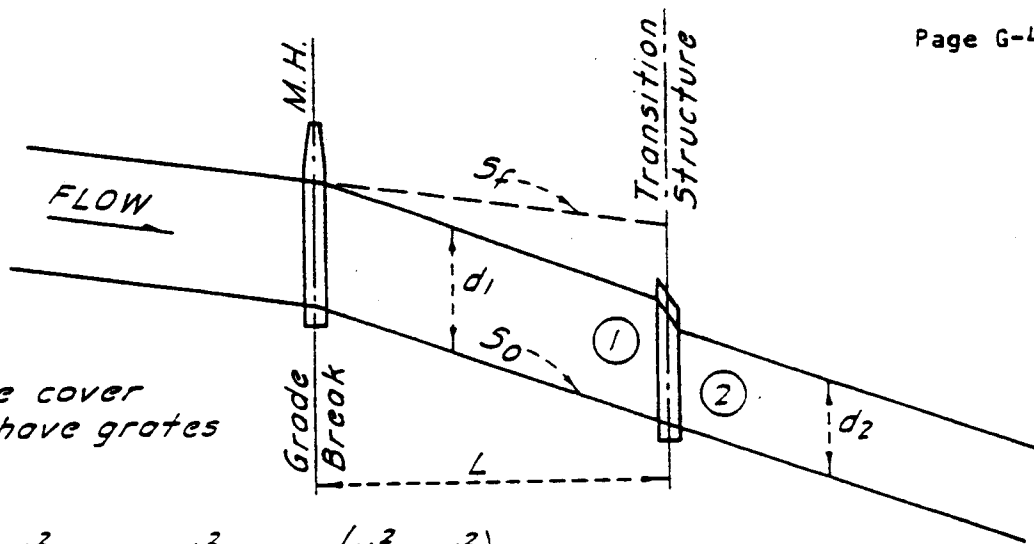
**NOTE:**

Manhole cover
should have grates

$$s_0 L + d_1 + \frac{v_1^2}{2g} = d_2 + \frac{v_2^2}{2g} + 0.1 \left(\frac{v_2^2}{2g} - \frac{v_1^2}{2g} \right) + s_f L + h_m, \text{ and}$$

$$s_0 L - s_f L = d_2 - d_1 + 1.1 \left(\frac{v_2^2}{2g} - \frac{v_1^2}{2g} \right) + h_m \dots \text{therefore:}$$

$$L = \frac{d_2 - d_1 + 1.1 \left(\frac{v_2^2}{2g} - \frac{v_1^2}{2g} \right) + h_m}{s_0 - s_f}$$

where s_0 = slope of conduit

s_f = friction slope of larger conduit

d_1 = diameter or depth of larger conduit

v_1 = velocity in larger conduit flowing full

d_2 = diameter or depth of smaller conduit

v_2 = velocity in smaller conduit flowing full

h_m = other losses occurring between the transition and the grade break such as bend and confluence losses

EXAMPLE PROBLEM

$$Q = 400 \text{ cfs}$$

$$d_1 = 84" = 7'$$

$$d_2 = 78" = 6.5'$$

$$A_1 = 38.49 \text{ sq. ft.}$$

$$A_2 = 33.18 \text{ sq. ft.}$$

$$v_1 = 10.4 \text{ fps}$$

$$v_2 = 12.0 \text{ fps}$$

$$\frac{v_1^2}{2g} = 1.68'$$

$$\frac{v_2^2}{2g} = 2.24'$$

$$s_0 = .00474$$

$$s_f = .00395$$

$$L = \frac{6.5 - 7.0 + 1.1(2.24 - 1.68)}{.00474 - .00395} \approx 147$$

Los Angeles County Flood Control District

LOCATION OF TRANSITION
LARGE TO SMALL CONDUIT

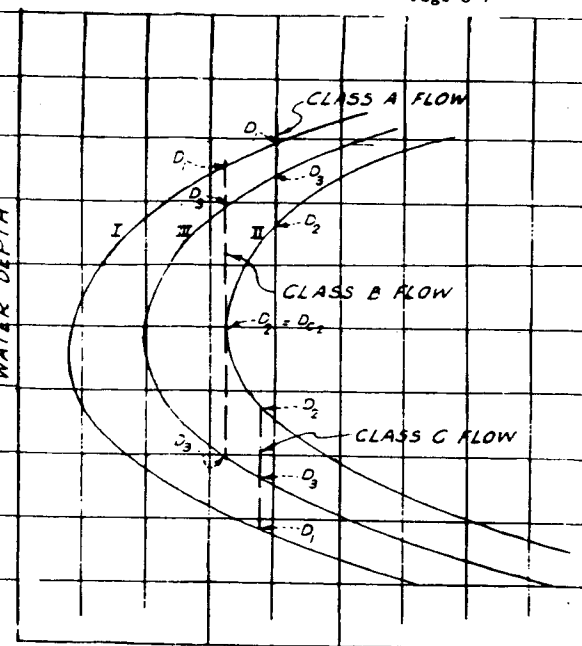
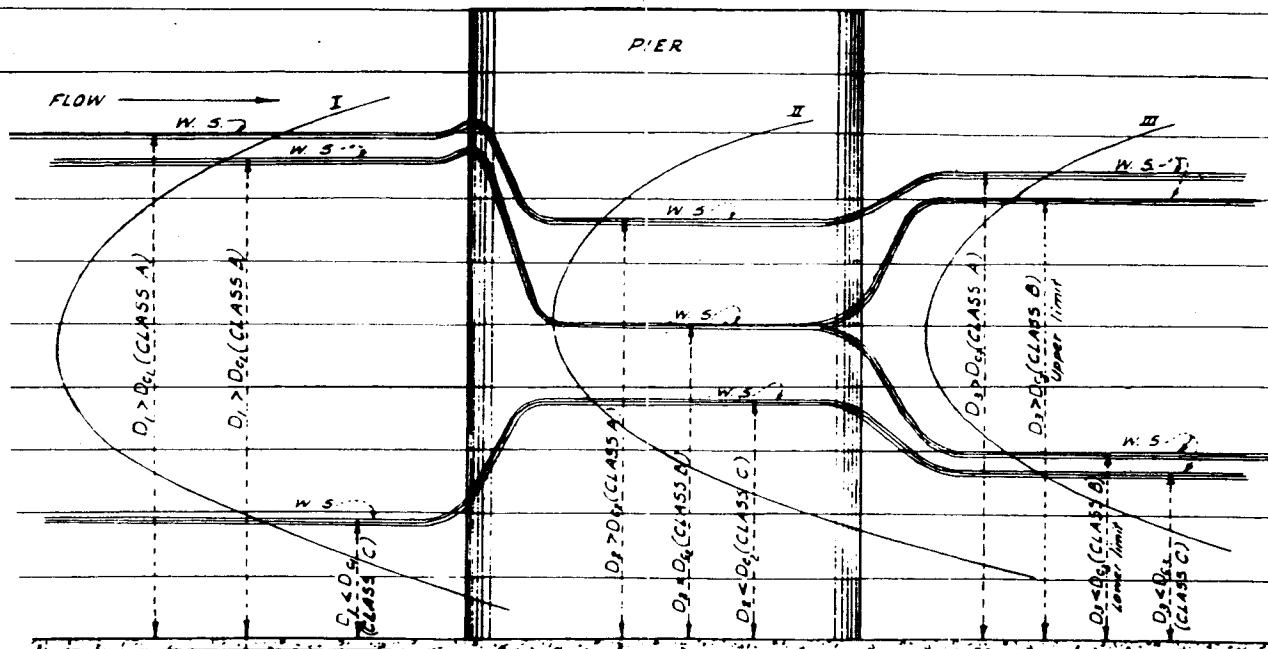

LONGITUDINAL PROFILE

PRESSURE+MOMENTUM CURVES

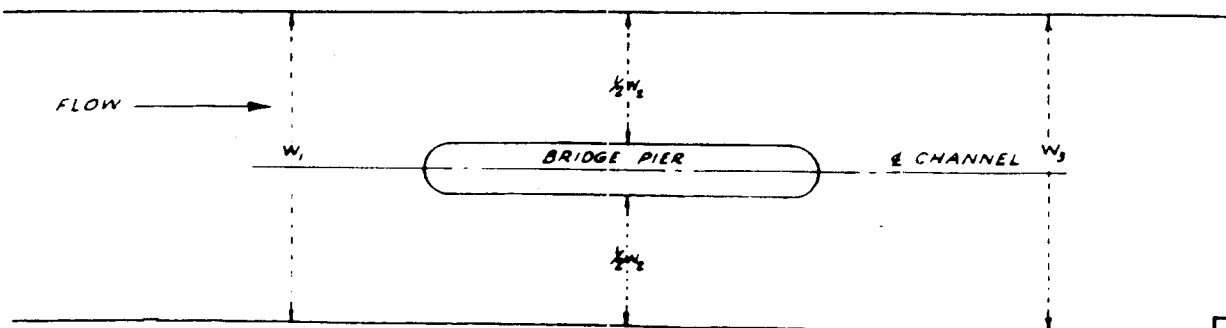

PLAN

GENERAL MOMENTUM EQUATION:

$$P_1 - P_p + \frac{Q^2}{gA_1^2} (A_1 - A_p) = P_2 + \frac{Q^2}{gA_2^2} = P_3 - P_p + \frac{Q^2}{gA_3^2}$$

NOTATIONS:

I, II, III = P-M curves upstream inside and downstream of bridge respectively.

C₁, D₁, D₃ = Water depths upstream, inside and downstream of bridge respectively.

D_{c2} = Critical depth within bridge.

W = Channel width.

P₁ = P₁ = Hydrostatic pressure in unobstructed channel.

P₂ = Hydrostatic pressure of bridge piers.

A₁ = A₃ = Area of unobstructed channel in sq. ft.

A_p = Area of bridge piers in sq. ft.

Q = Discharge in c.f.s.

g = Gravitational constant.

D_{c1} = D_{c3} = Critical in unobstructed channel.

* Use $\frac{2}{3} A_p$ for round nose piers.

Los Angeles County Flood Control District

BRIDGE PIER LOSSES BY THE MOMENTUM METHOD

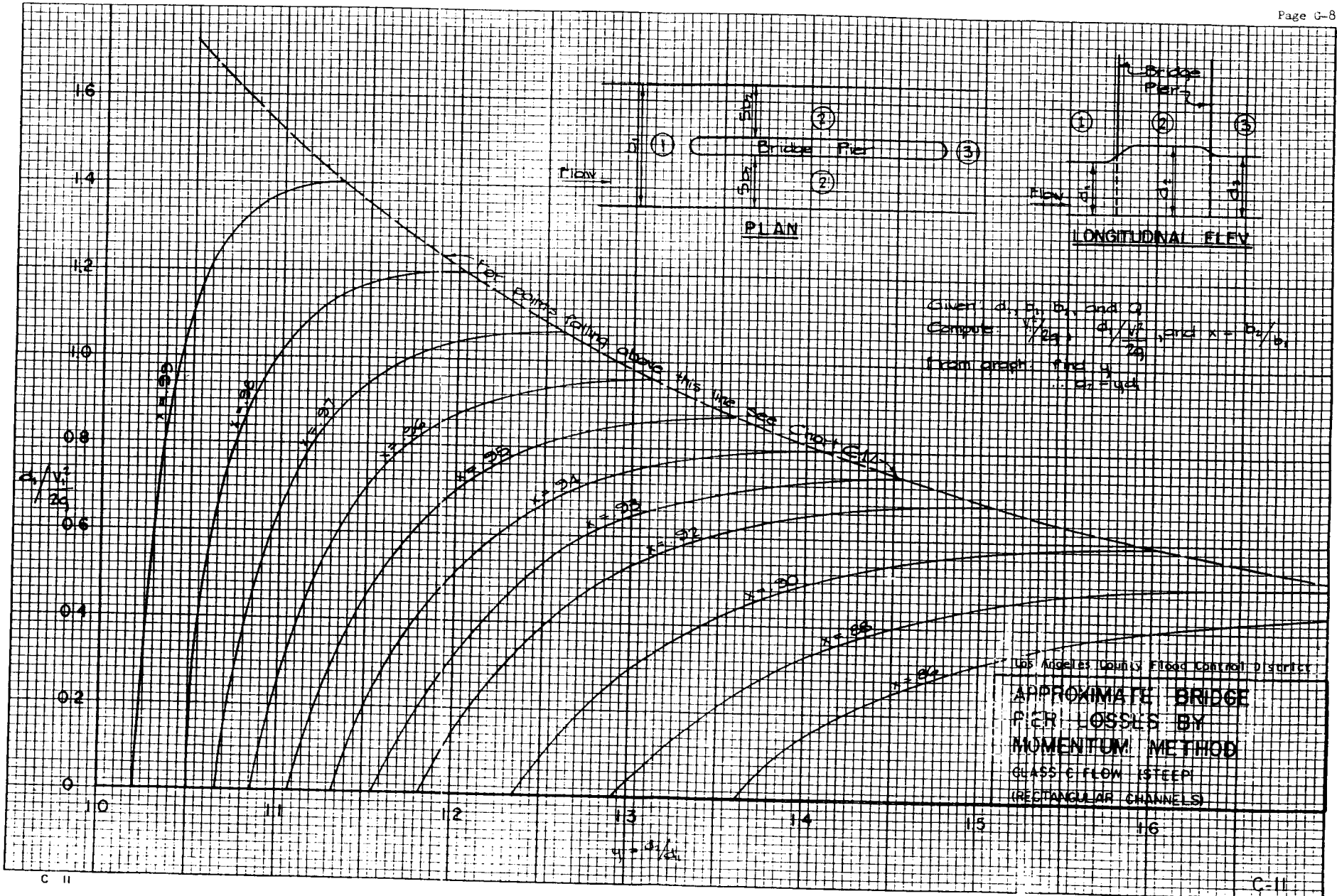

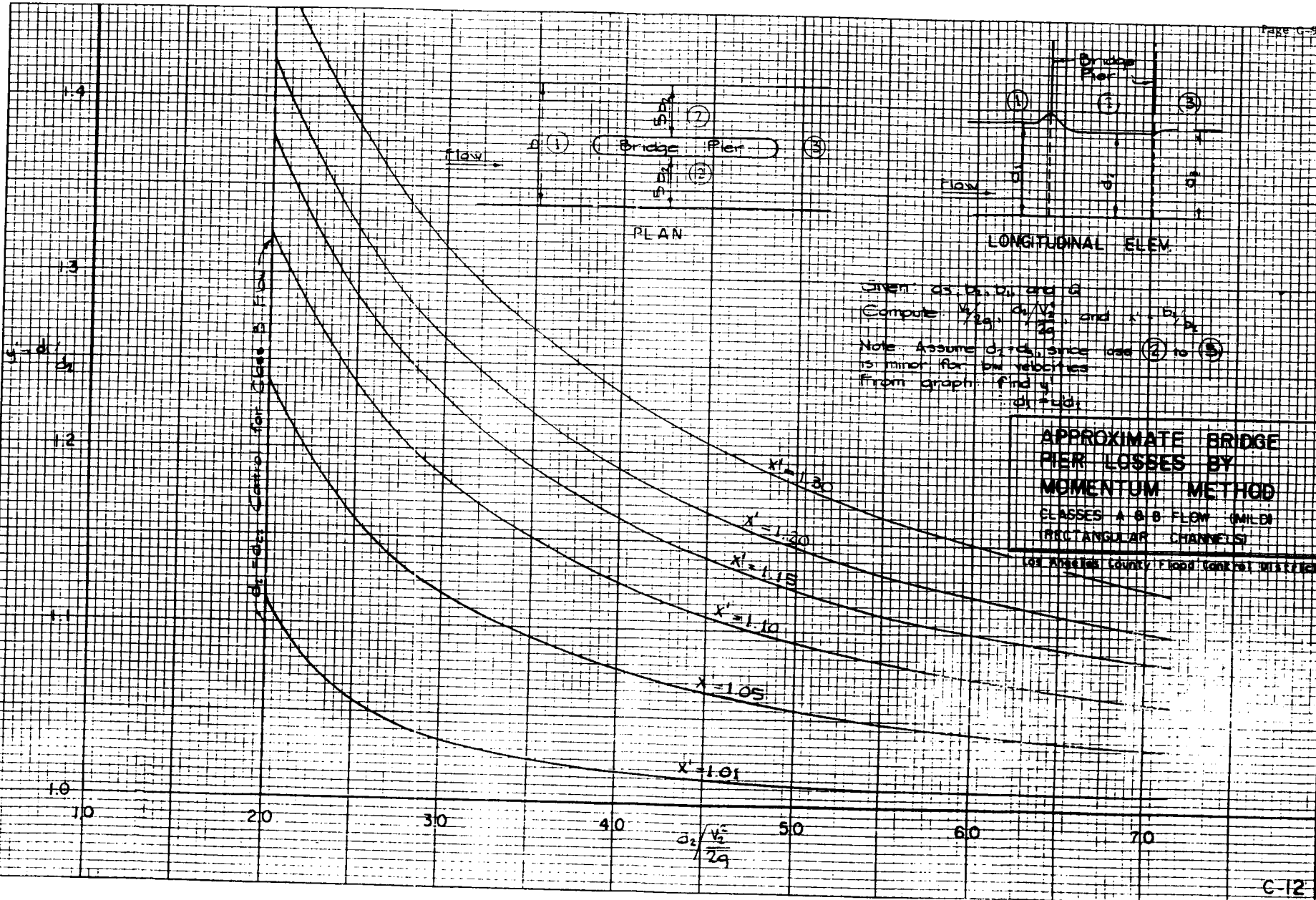
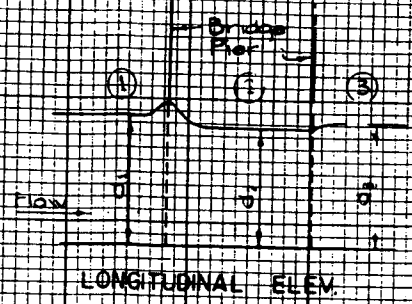
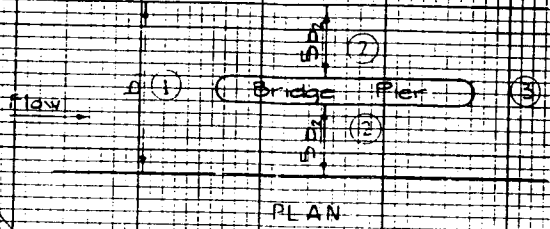

Given: d_1 , b_1 , b_2 , and Q
 Compute $v_1/\sqrt{2g}$, $d_1/\sqrt{2g}$, and $x = b_1/d_1$
 Note: Assume $d_2 = d_1$, since use (2) to (5)
 is minor for low velocities
 From graph find y
 or d_2

**APPROXIMATE BRIDGE
 PIER LOSSES BY
 MOMENTUM METHOD**
 CLASSES A & B FLOW (MILD)
 RECTANGULAR CHANNELS
 (See Appendix C, Flood Control District)

CONVERGING TRANSITION - SUPERCRITICAL FLOW

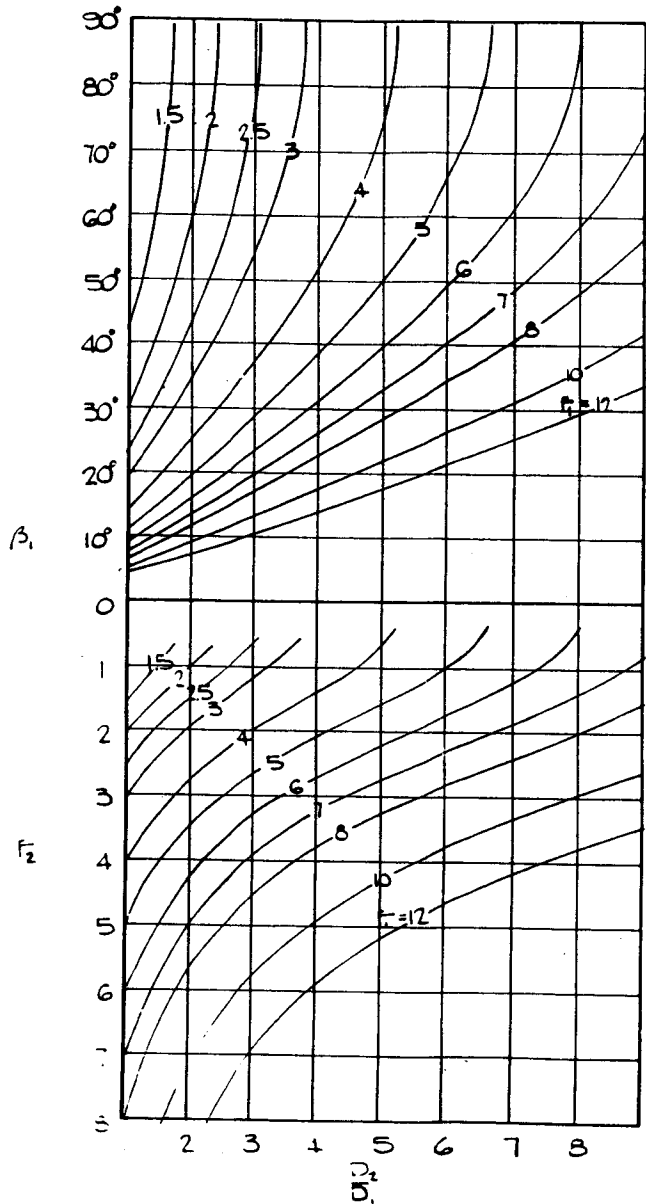
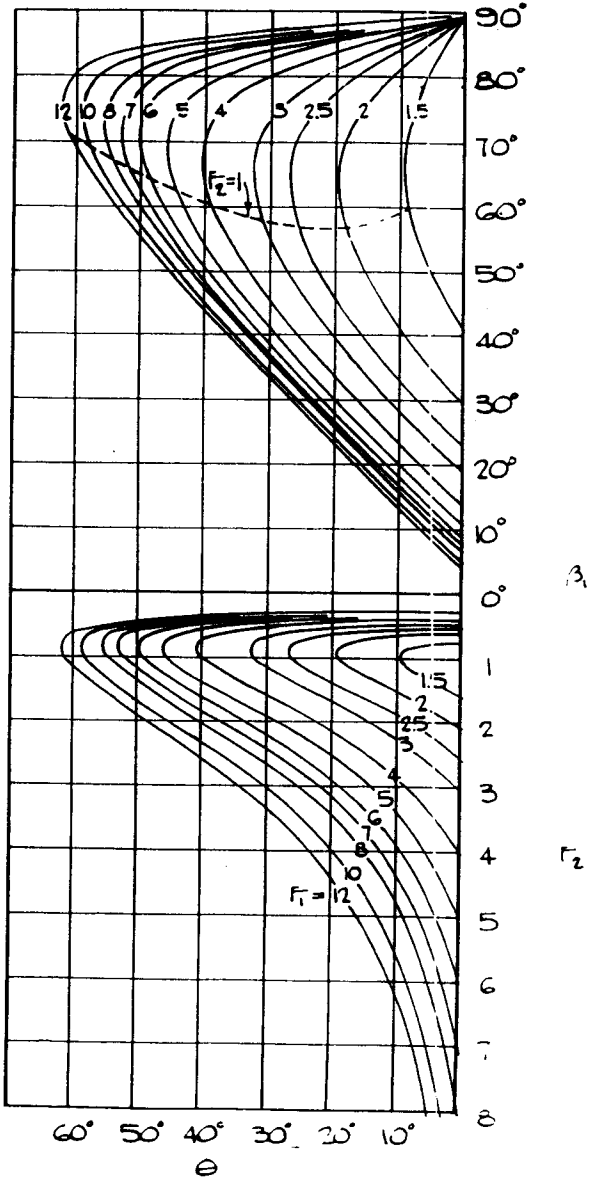

General relations between $F_1, \theta, \beta, D_2/D_1$ and F_2

**ROLL WAVES
MAXIMUM WAVE HEIGHT**

Los Angeles County Flood Control District

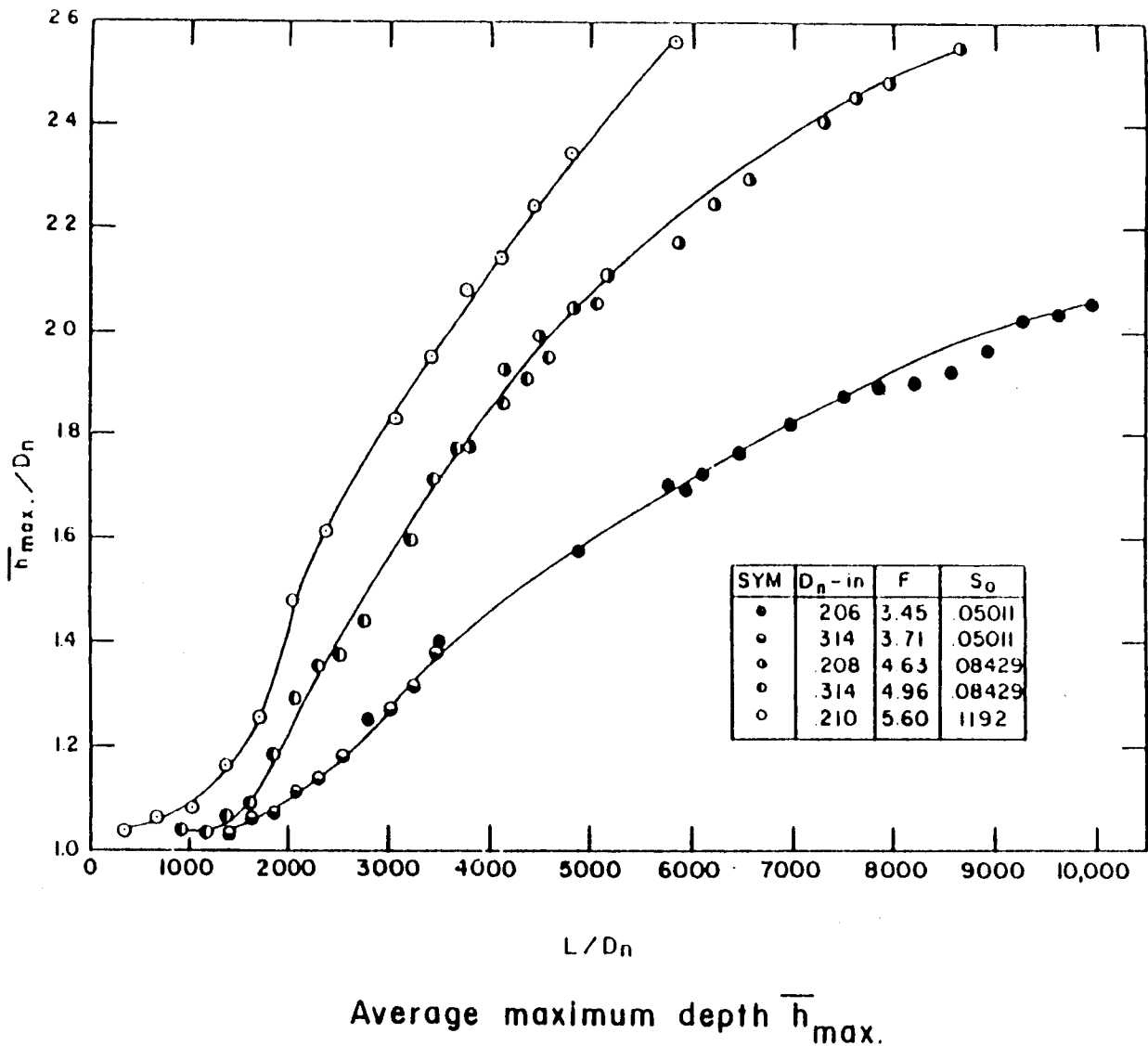

ROLL WAVES
MAXIMUM WAVE HEIGHT

Los Angeles County Flood Control District

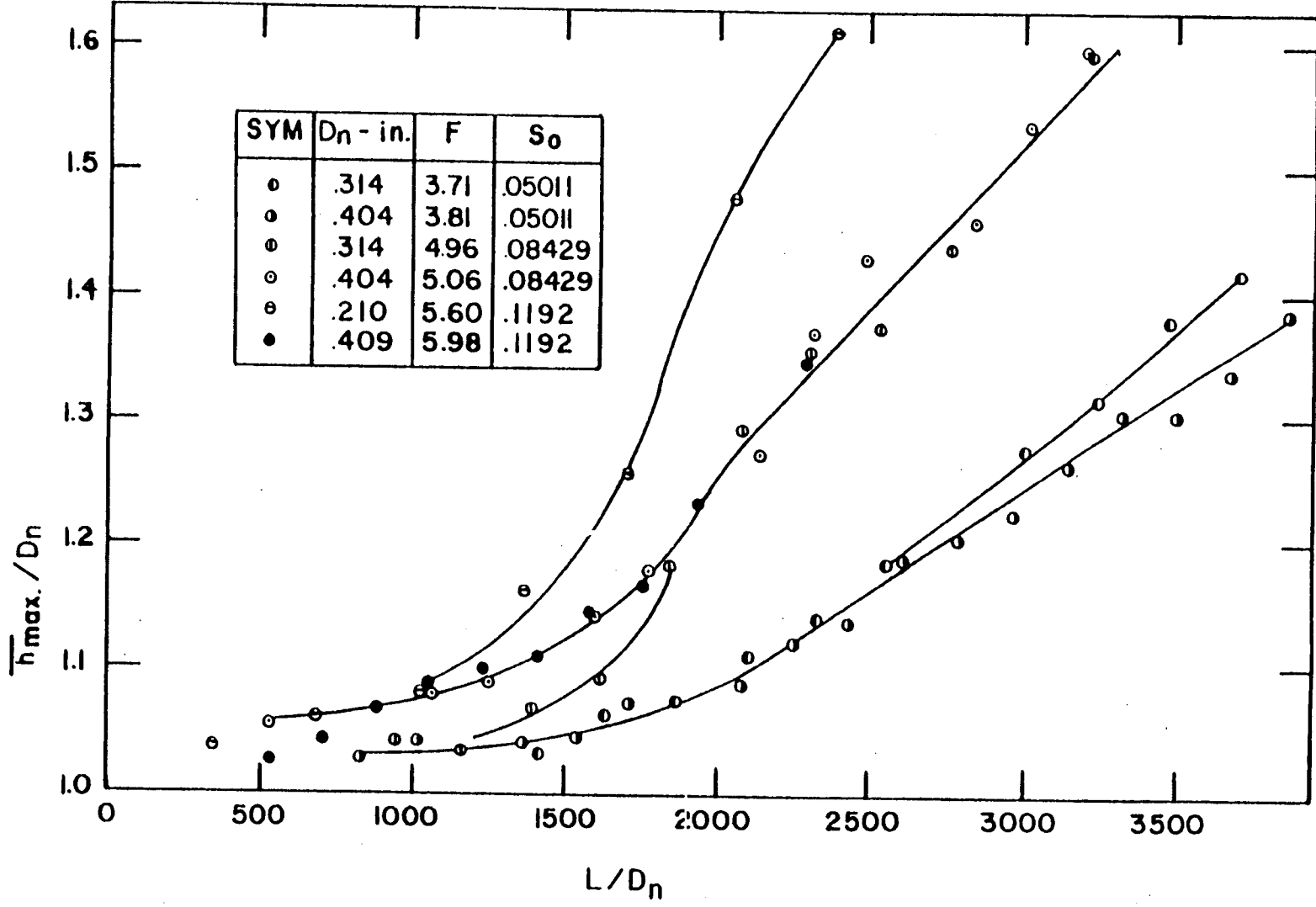

Average maximum depth \bar{h}_{max} .

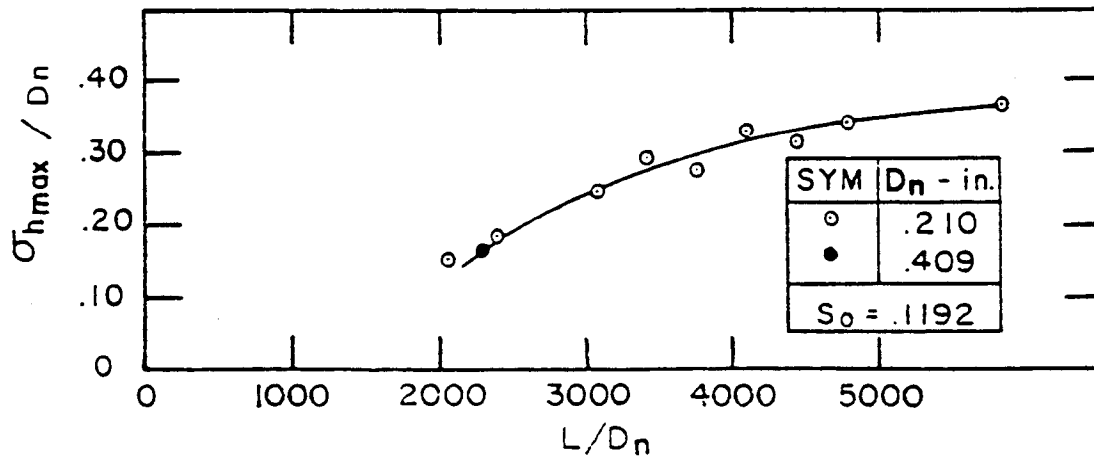
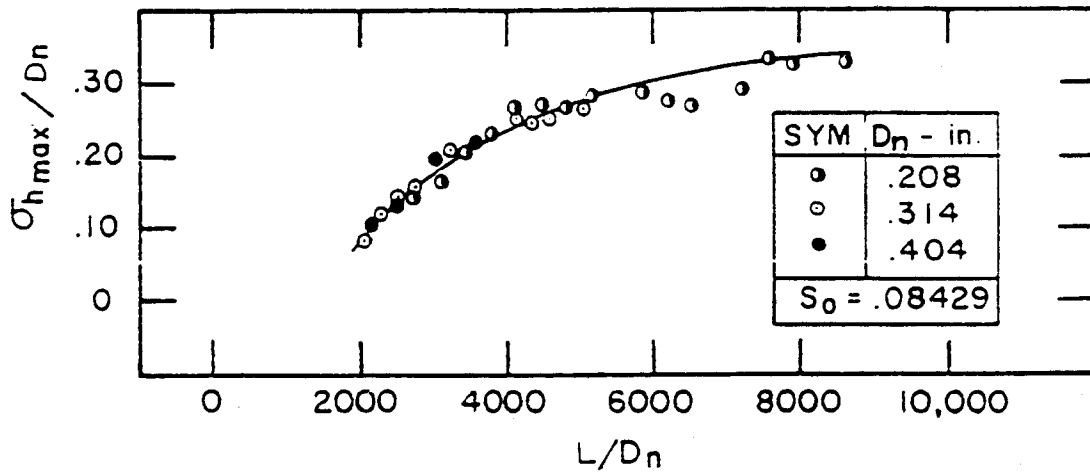
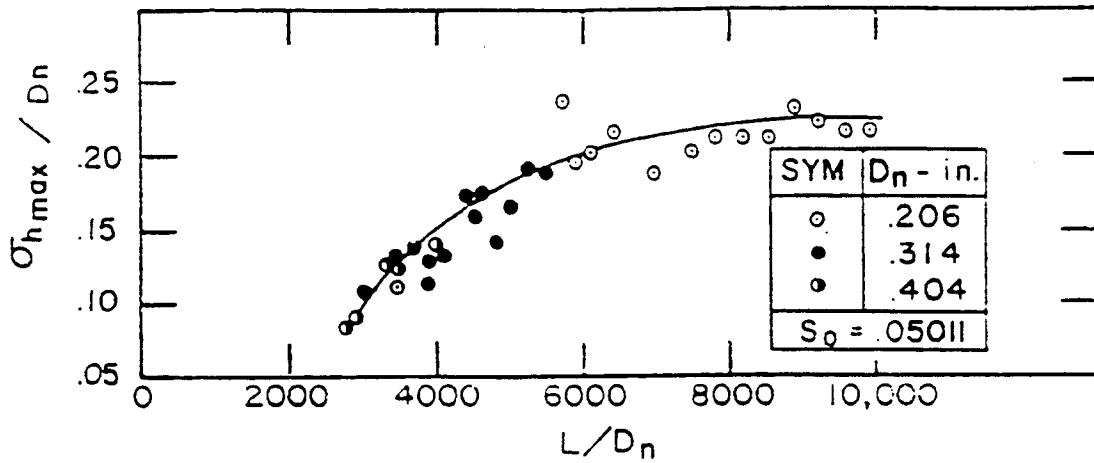

Standard deviation of the maximum depth, $\sigma_{h_{max}}$.

**ROLL WAVES
MAXIMUM WAVE HEIGHT**

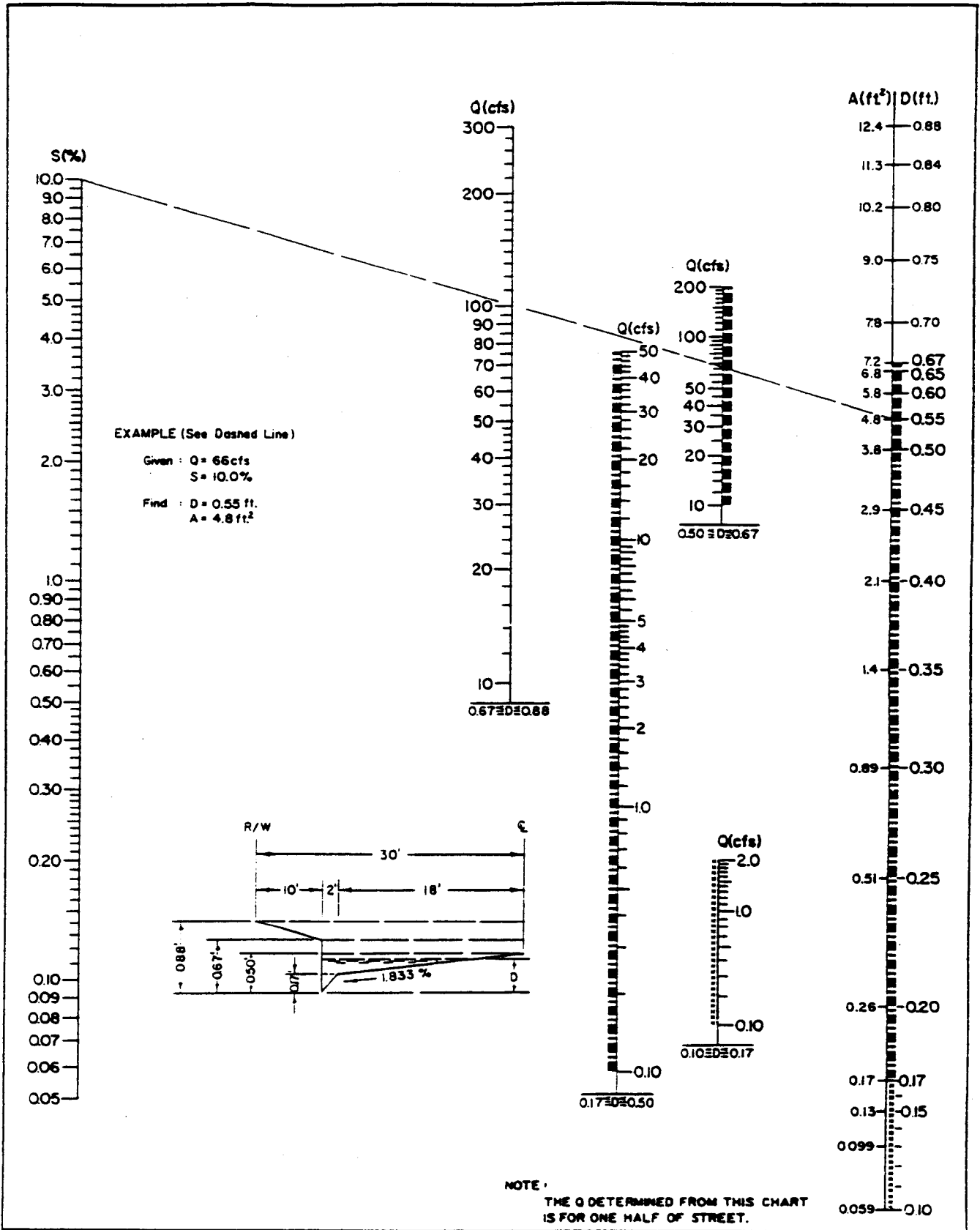

DESIGNED BY GB 6-64
 CHECKED BY JJM 8-64

LOS ANGELES COUNTY ROAD DEPARTMENT

STREET FLOW
 LOCAL ST.-Chart 1 of 1

REFERENCE SHEET

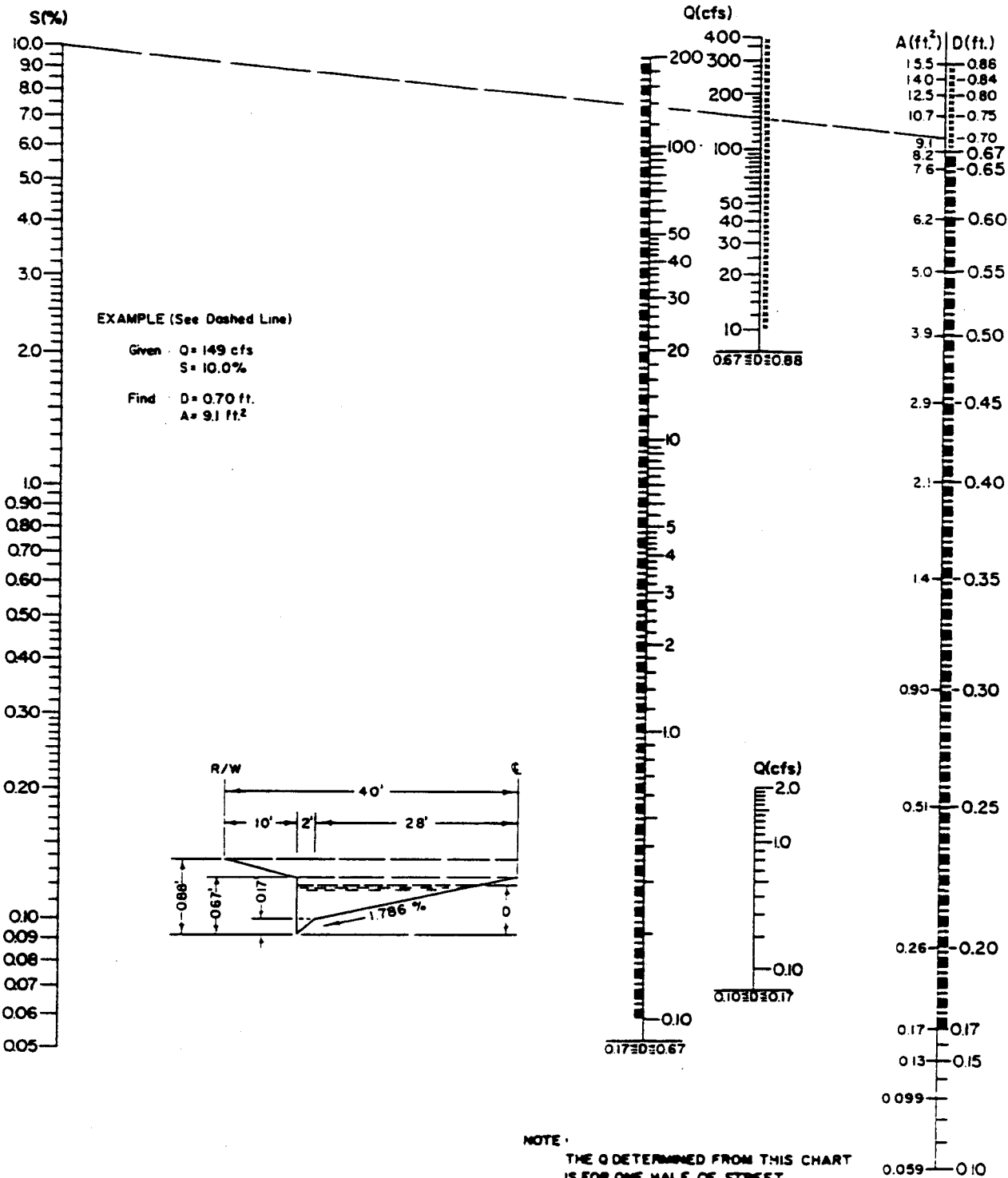

DESIGNED BY W.B. 0-64
CHECKED BY J.J.M. 8-64

LOS ANGELES COUNTY ROAD DEPARTMENT

STREET FLOW
SECONDARY HWY. - Chart 1 of 2

REFERENCE SHEET

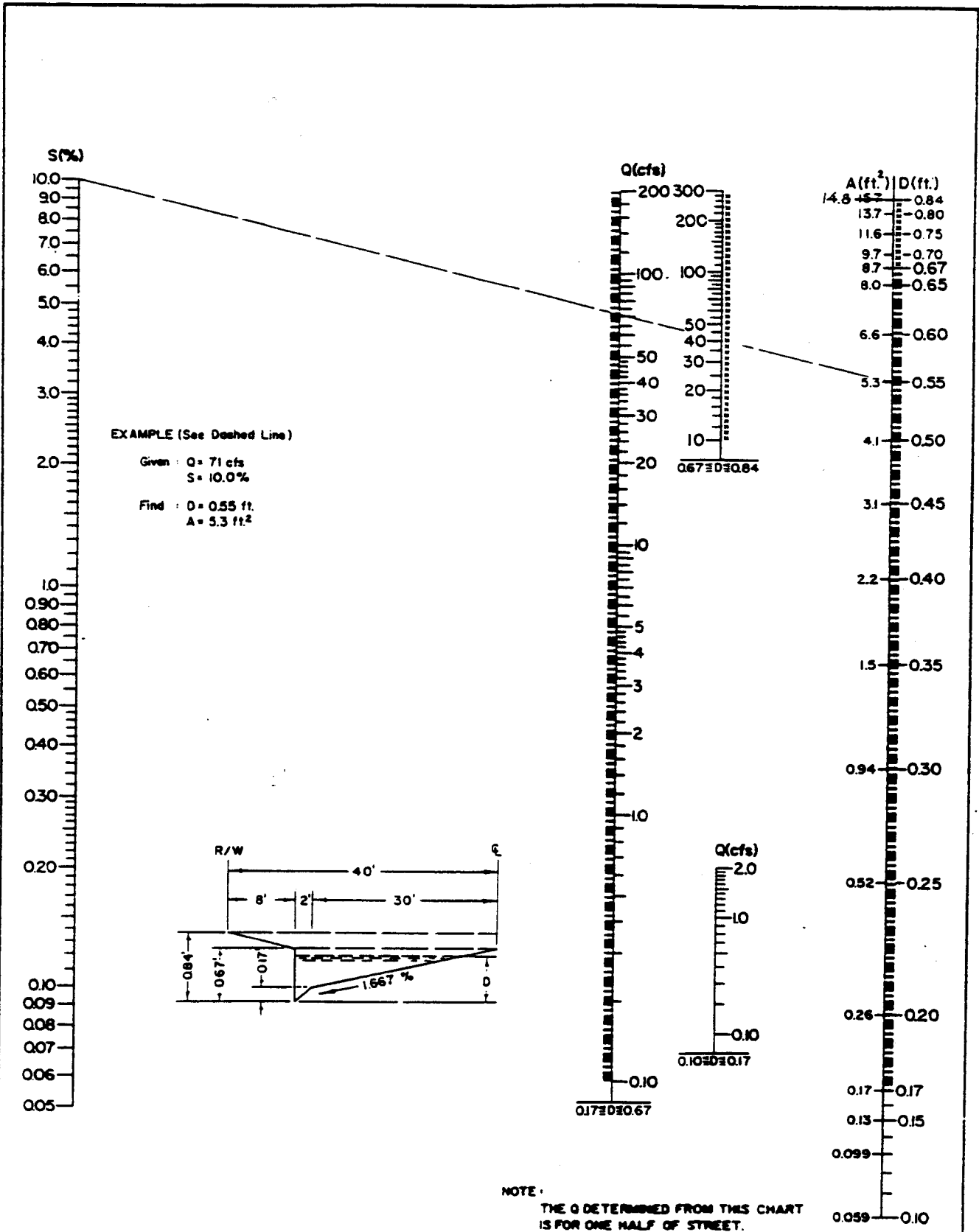

DESIGNED BY G.B. 8-64
CHECKED BY J.J.M. 8-64

LOS ANGELES COUNTY ROAD DEPARTMENT

STREET FLOW
SECONDARY HWY. - Chart 2 of 2

REFERENCE SHEET

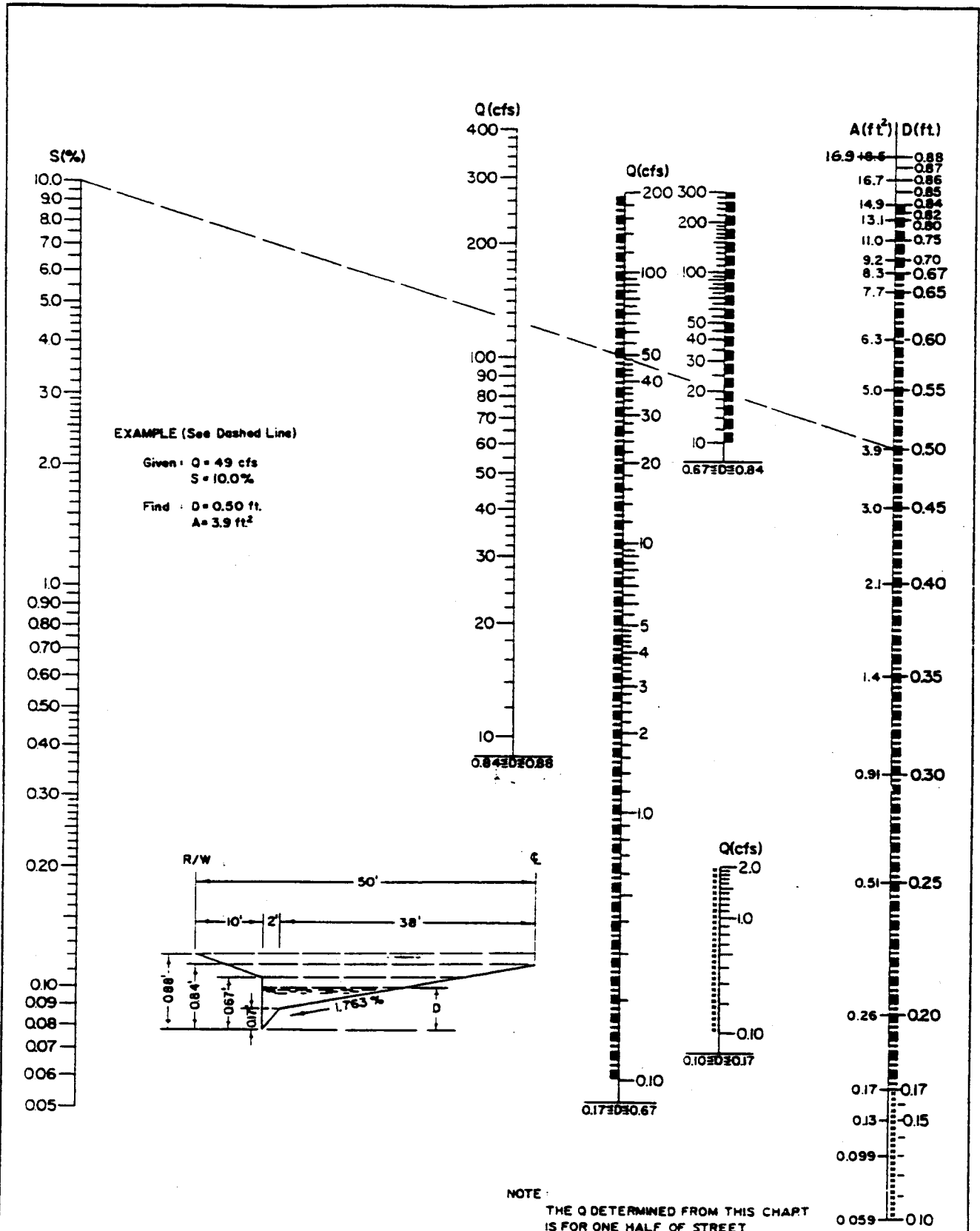

DESIGNED BY G.B. 8-64
 CHECKED BY J.J.M. 8-64

LOS ANGELES COUNTY ROAD DEPARTMENT

STREET FLOW
 MAJOR HWY. - Chart 1 of 5

REFERENCE SHEET

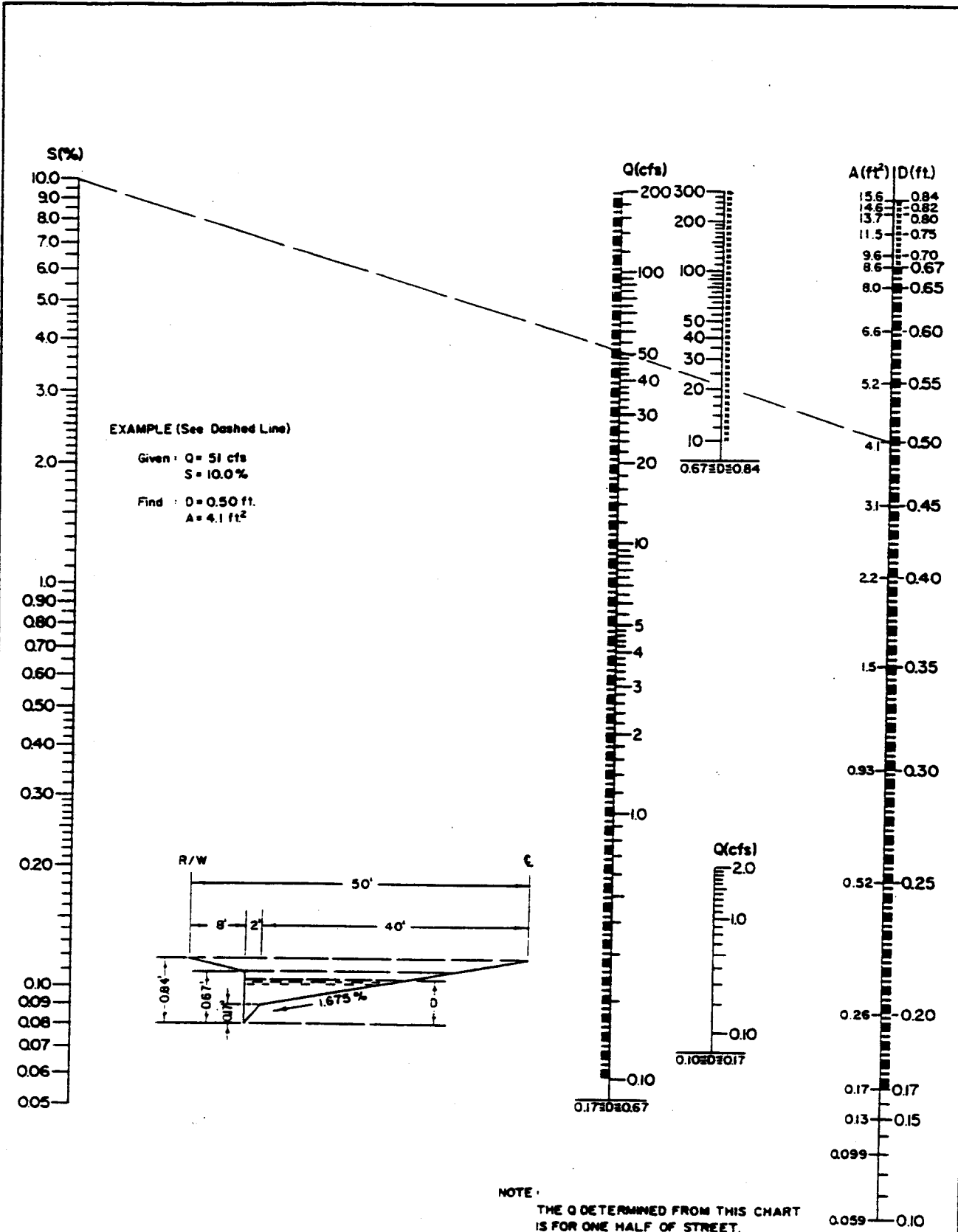

LOS ANGELES COUNTY ROAD DEPARTMENT

STREET FLOW
 MAJOR HWY. - Chart 2 of 5

REFERENCE SHEET

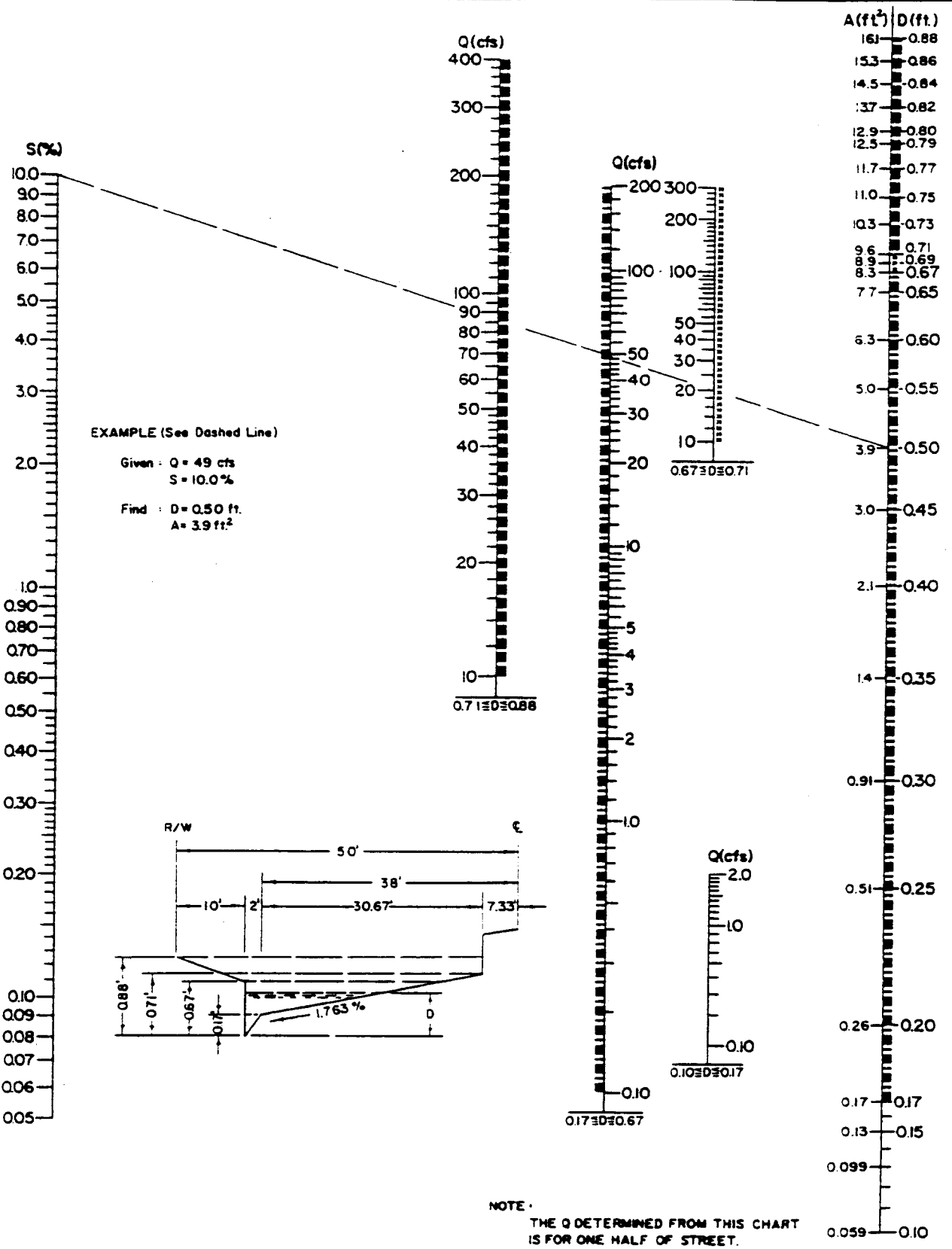

DESIGNED BY G.B. 8-64
 CHECKED BY J.J.M. 8-64

LOS ANGELES COUNTY ROAD DEPARTMENT

STREET FLOW
 MAJOR HWY.-Chart 3 of 5

REFERENCE SHEET

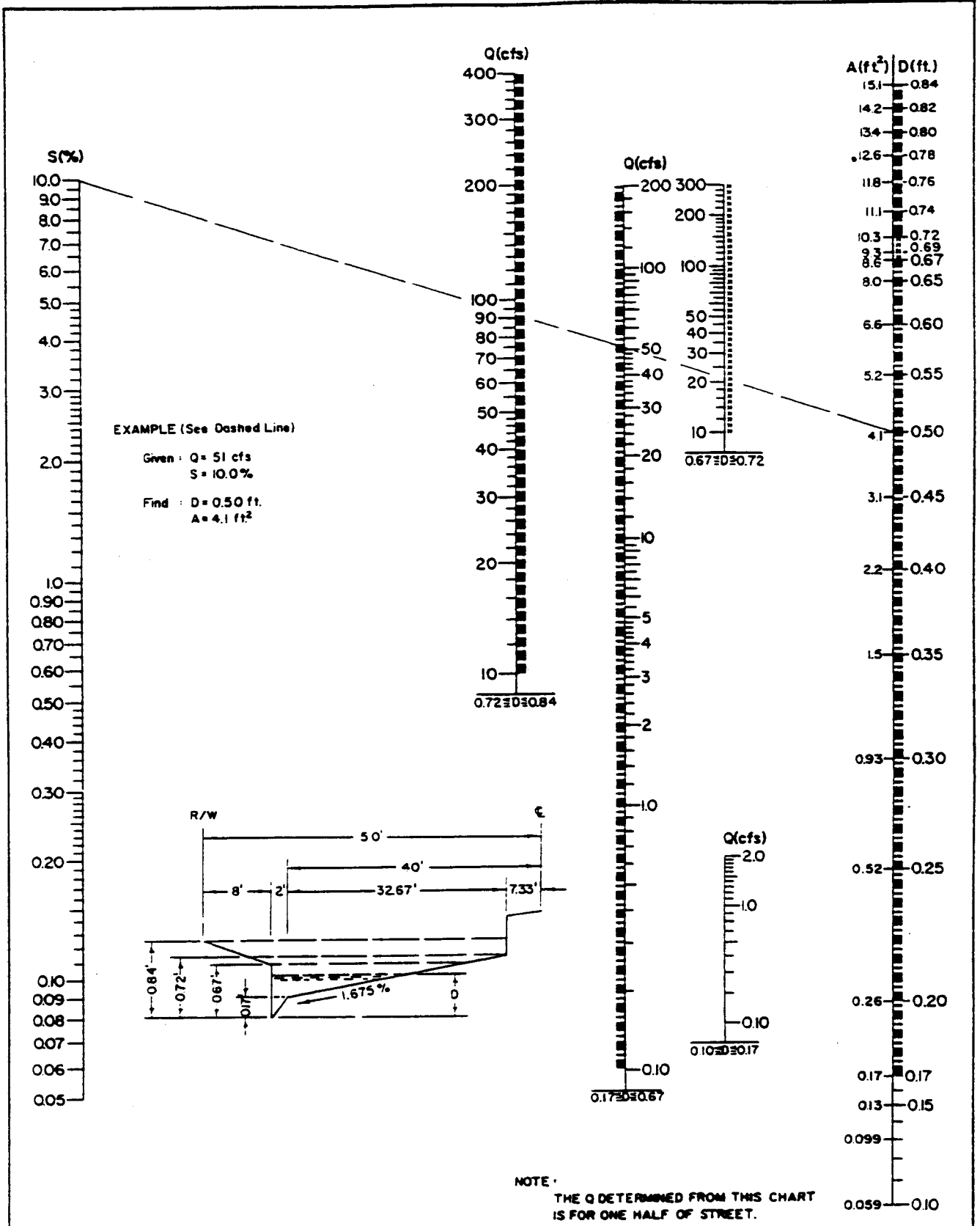

DESIGNED BY GB 8-64
 CHECKED BY J.J.M. 8-64

LOS ANGELES COUNTY ROAD DEPARTMENT

STREET FLOW
 MAJOR HWY.- Chart 4 of 5

REFERENCE SHEET

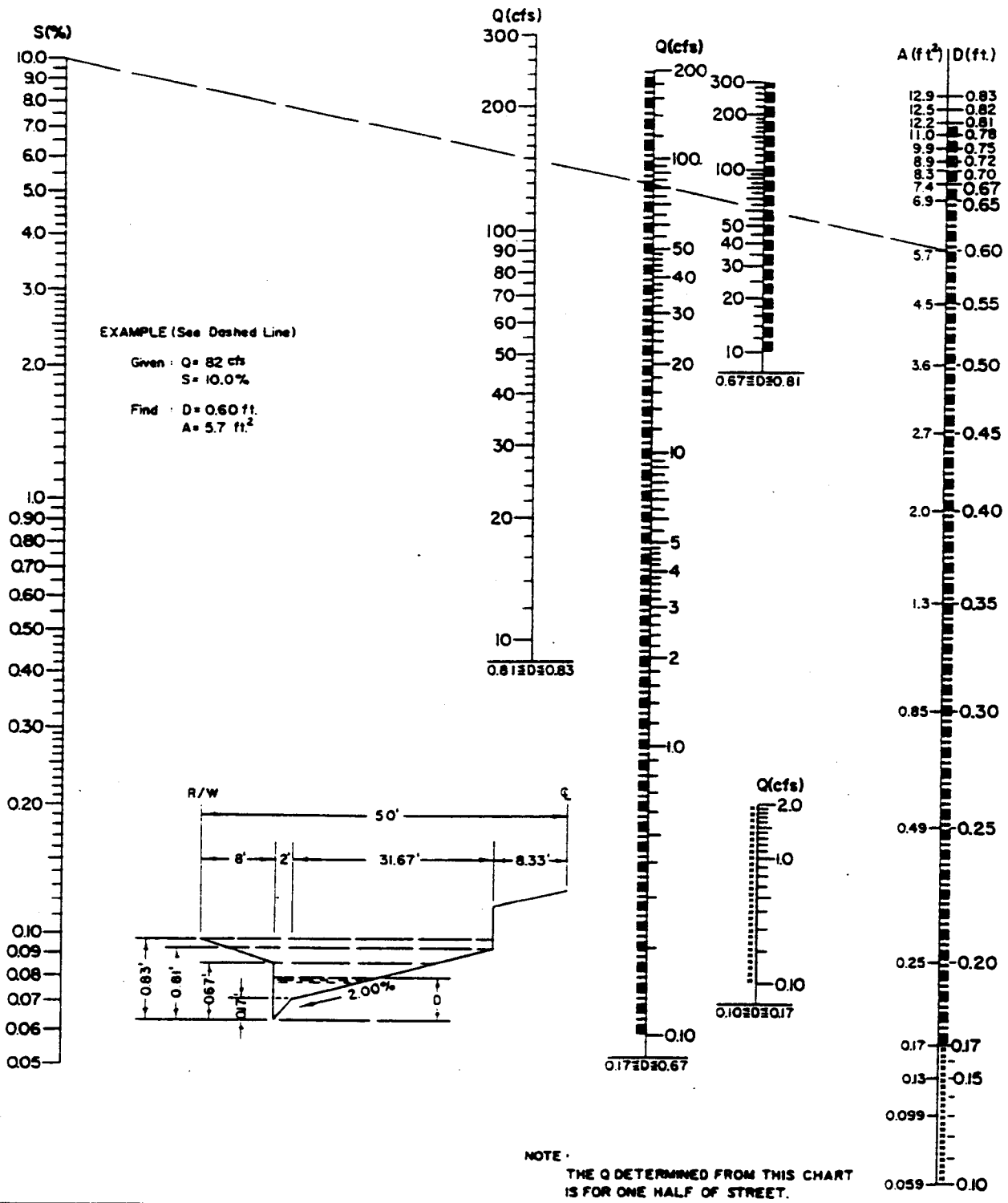

DESIGNED BY U.S. 6-64
 CHECKED BY J.J.M. 8-64

LOS ANGELES COUNTY ROAD DEPARTMENT

STREET FLOW
 MAJOR HWY. - Chart 5 of 5

REFERENCE SHEET

Los Angeles County Flood Control District

STREET CAPACITY CHARTS

The Street Capacity Charts D-01 to D-08 are based on the following formulas: (The formulas are a variation of the Manning formula and ignore the friction along the vertical face of the curb as being insignificant).

Manning's "n"

Curb to curb "n" = .015

Curb to R/W "n" = .018

"s" = street slope

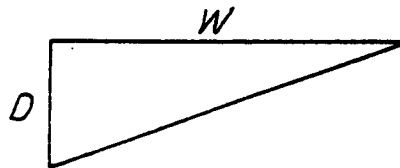
Triangular Shaped Areas

$$Q = \frac{3}{8} \left[\frac{1.486 D^{\frac{5}{3}} s^{\frac{1}{2}} W}{n} \right]$$

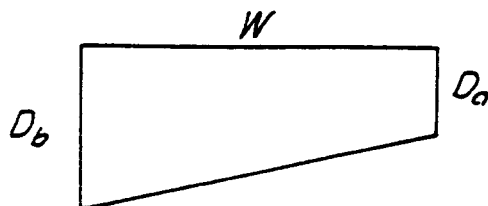
Trapezoidal Shaped Areas

$$Q = \frac{3}{8} \cdot \frac{1.486 s^{\frac{1}{2}}}{n} \left[\frac{D_b^{\frac{8}{3}} - D_a^{\frac{8}{3}}}{D_b - D_a} \right] W$$

1st GUTTER DEPRESSION

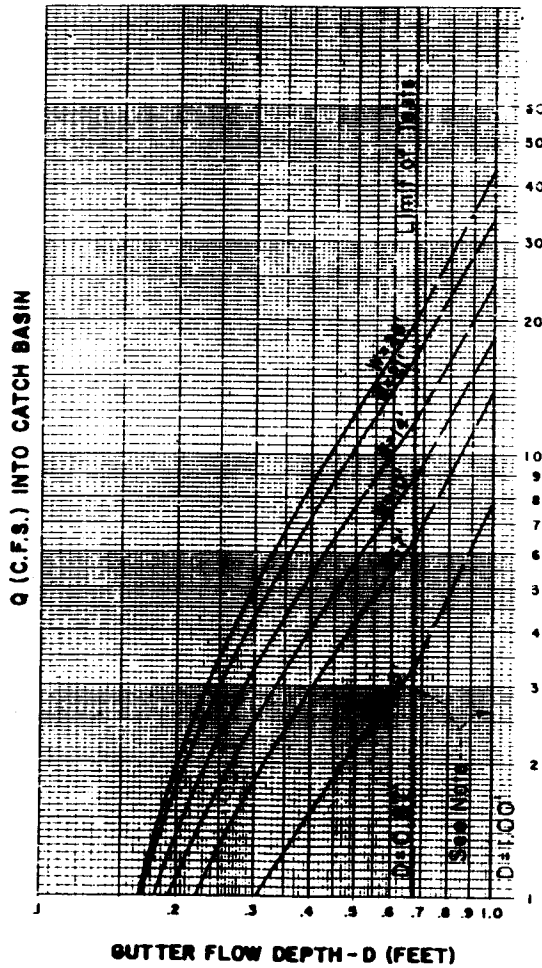

2nd GUTTER DEPRESSION

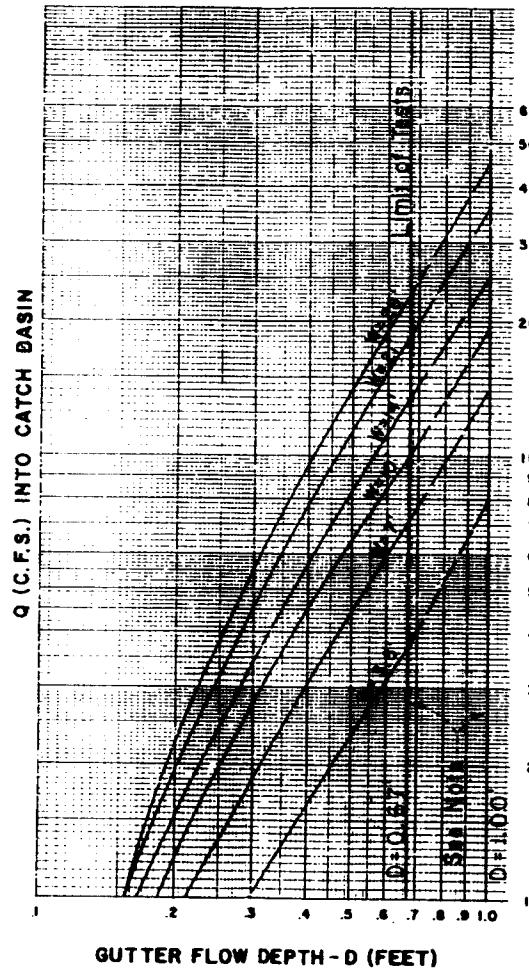

4th GUTTER DEPRESSION

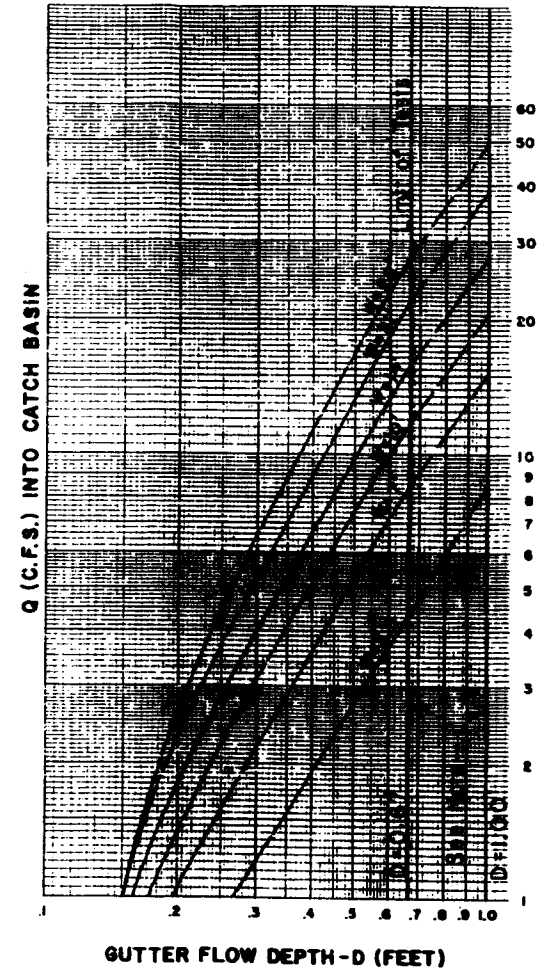

NOTE: Curves between $D=0.67'$ and $1.0'$ are not from model test data and will be revised in the future when additional model test data are available.

CURB OPENING CATCH BASIN CAPACITIES

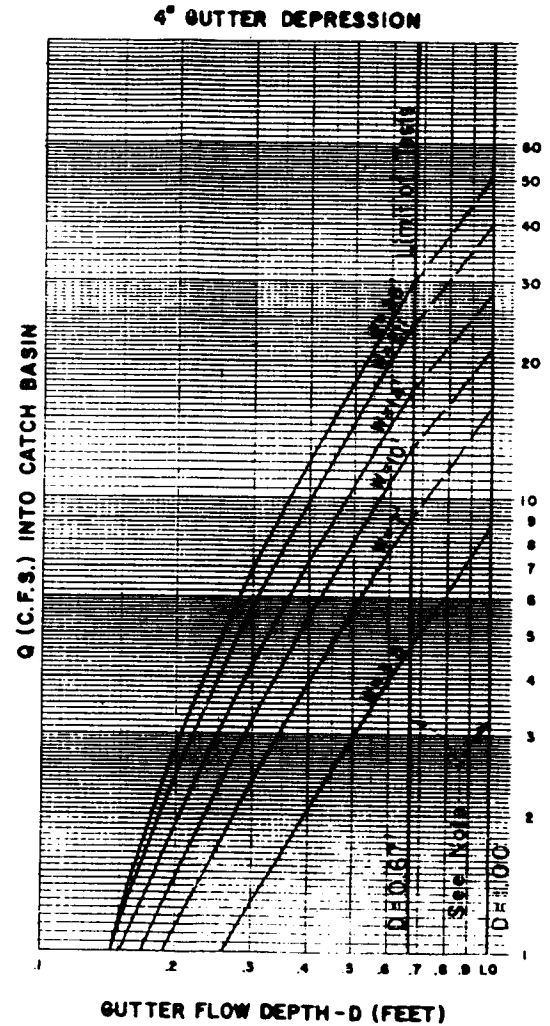
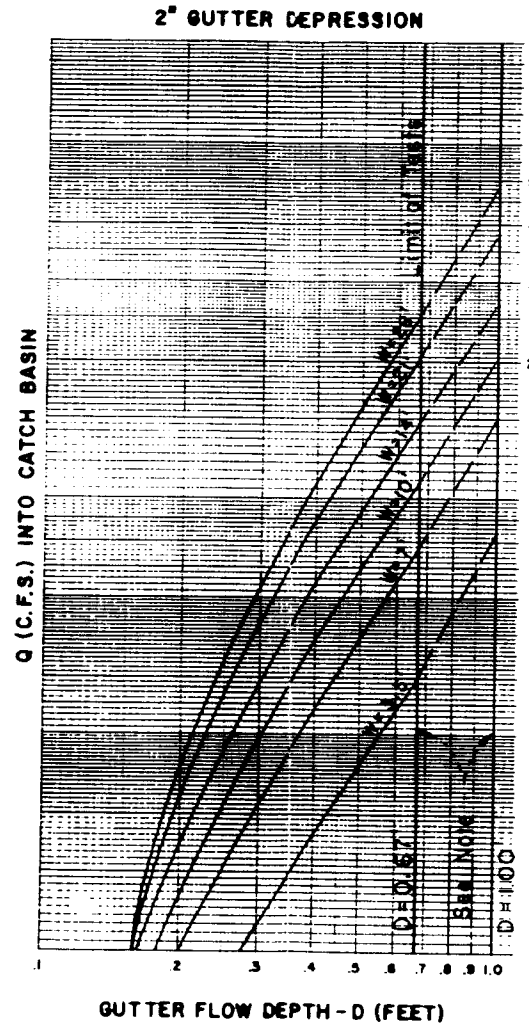
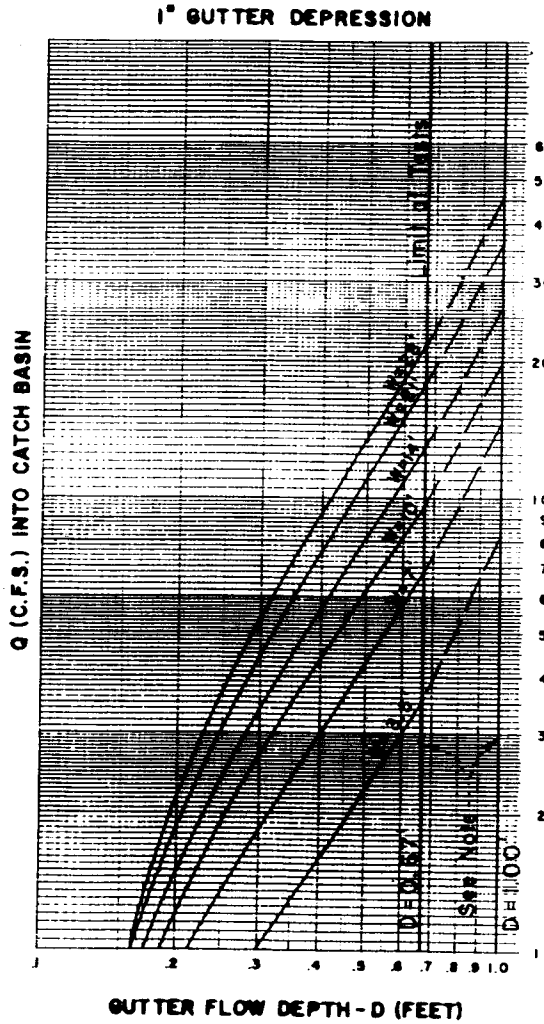

NOTE: Curves between D=0.67' and 1.0' are not from model test data and will be revised in the future when additional model test data are available.

CURB OPENING CATCH BASIN CAPACITIES

STREET SLOPE = .01

1" GUTTER DEPRESSION

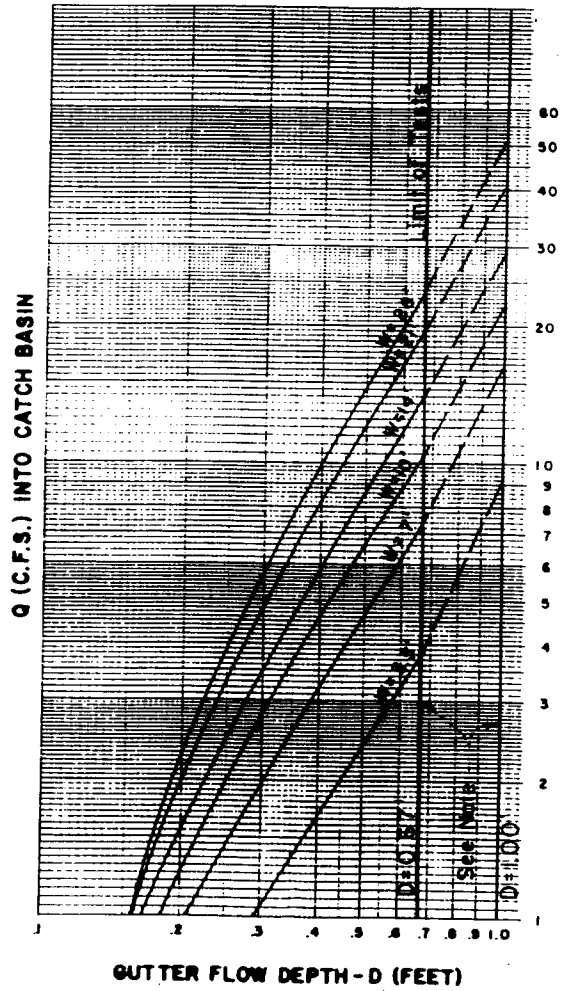

2" GUTTER DEPRESSION

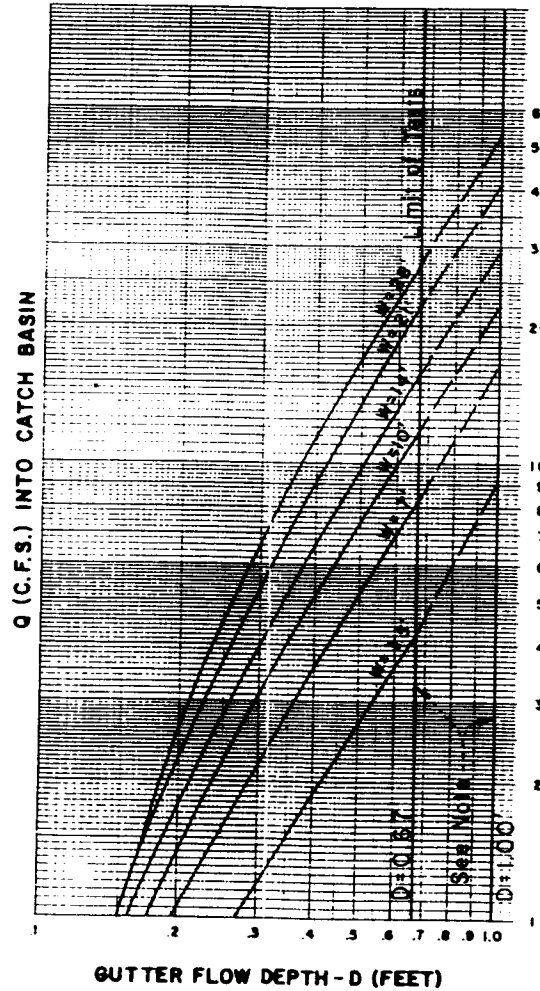

4" GUTTER DEPRESSION

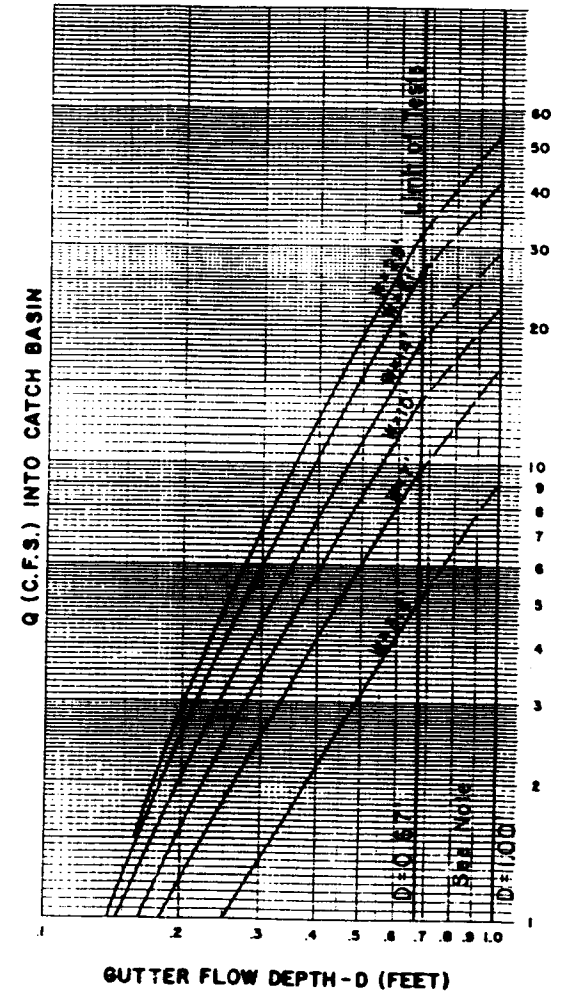

NOTE: Curves between D=0.67' and 1.0' are not from model test data and will be revised in the future when additional model test data are available.

CURB OPENING CATCH BASIN CAPACITIES

STREET SLOPE = .03

D-10C

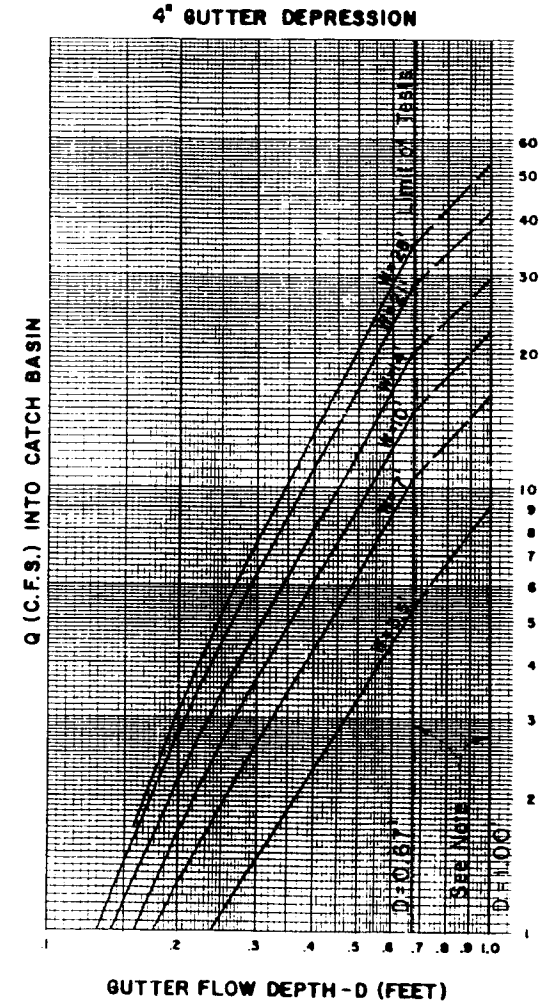
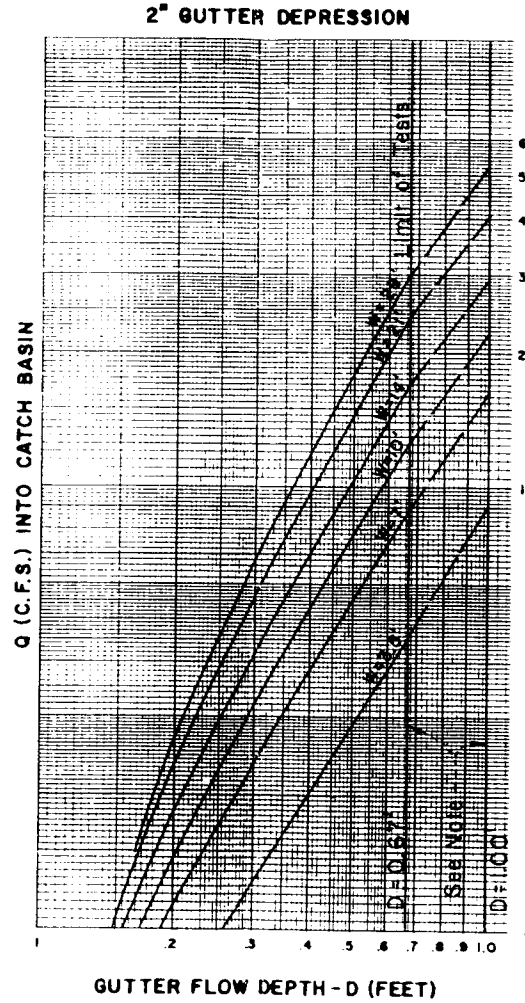
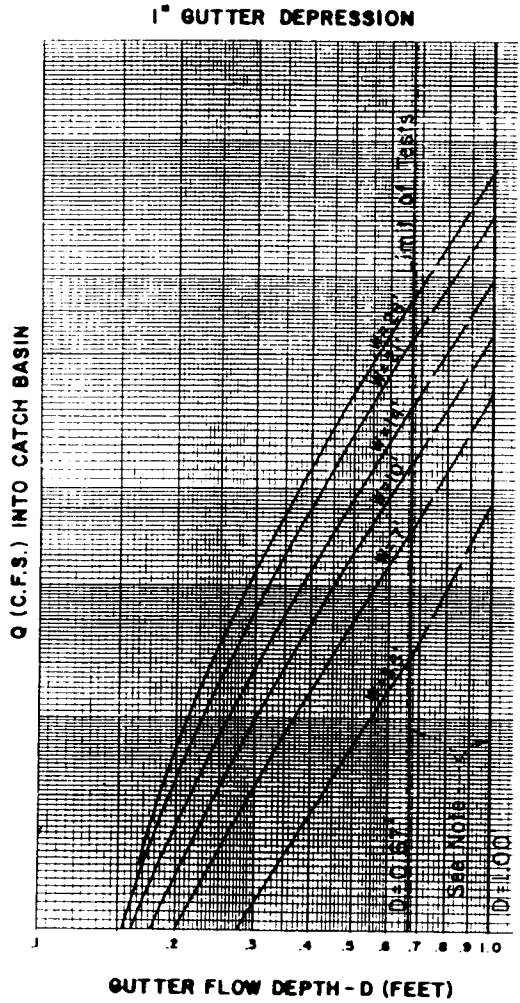

NOTE: Curves between D=0.67' and 1.0' are not from model test data and will be revised in the future when additional model test data are available.

CURB OPENING CATCH BASIN CAPACITIES

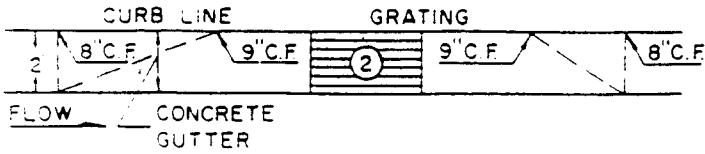

GRATING & GUTTER PLAN

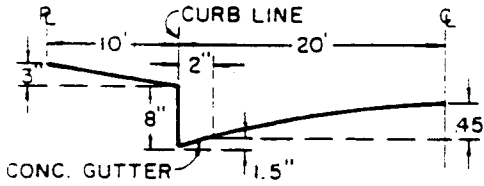

TYPICAL HALF STREET SECTION (ABOVE BASIN)

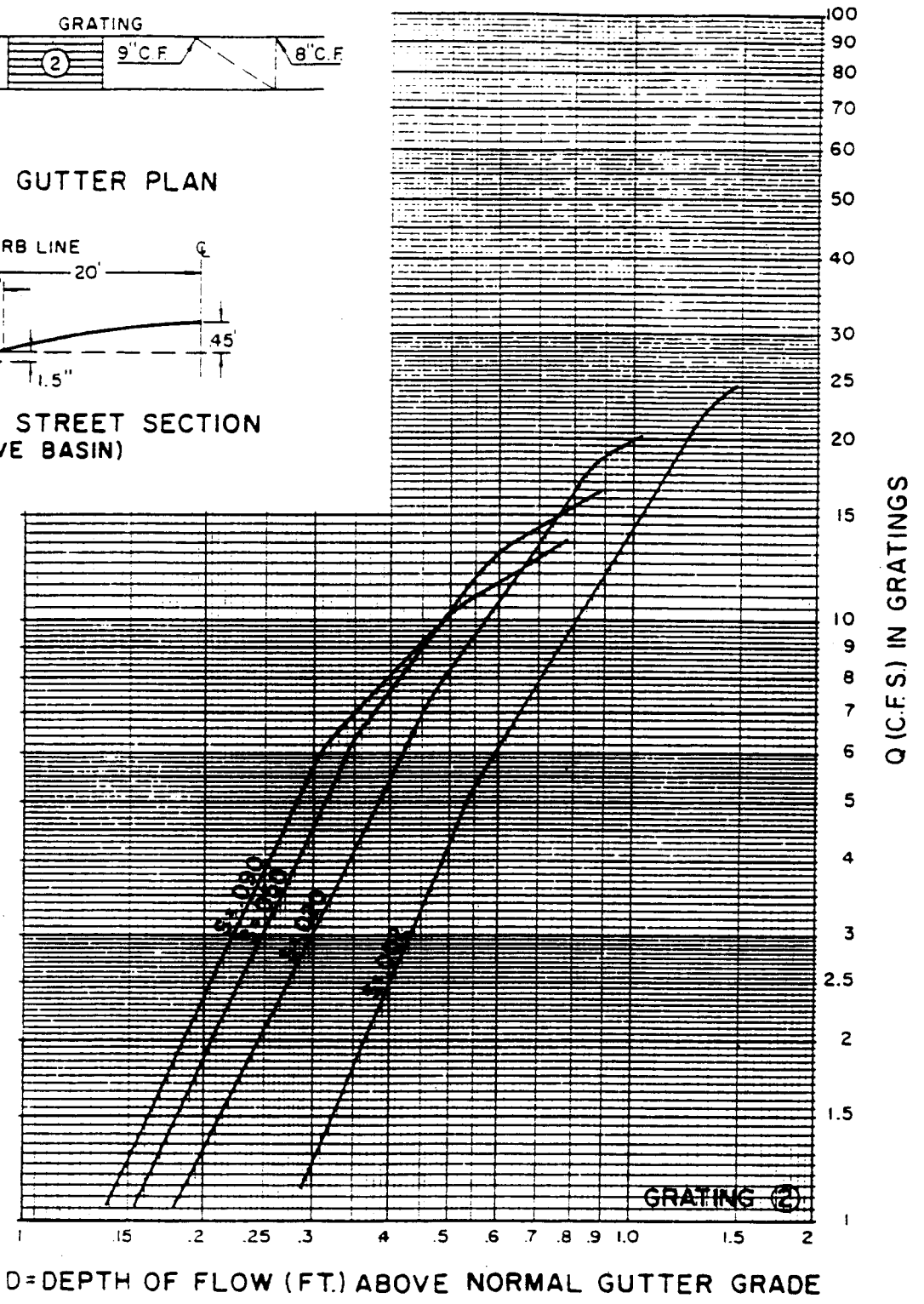

D=DEPTH OF FLOW (FT.) ABOVE NORMAL GUTTER GRADE

Los Angeles County Flood Control District

GRATING CAPACITIES
To Be Used For C.B. Nos. 4, 5 & 7

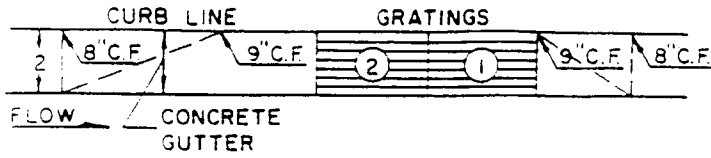

GRATING & GUTTER PLAN

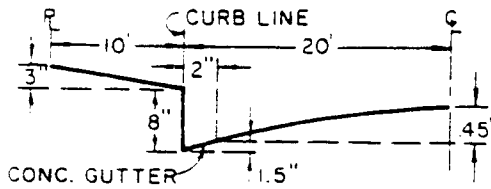

TYPICAL HALF STREET SECTION
(ABOVE BASIN)

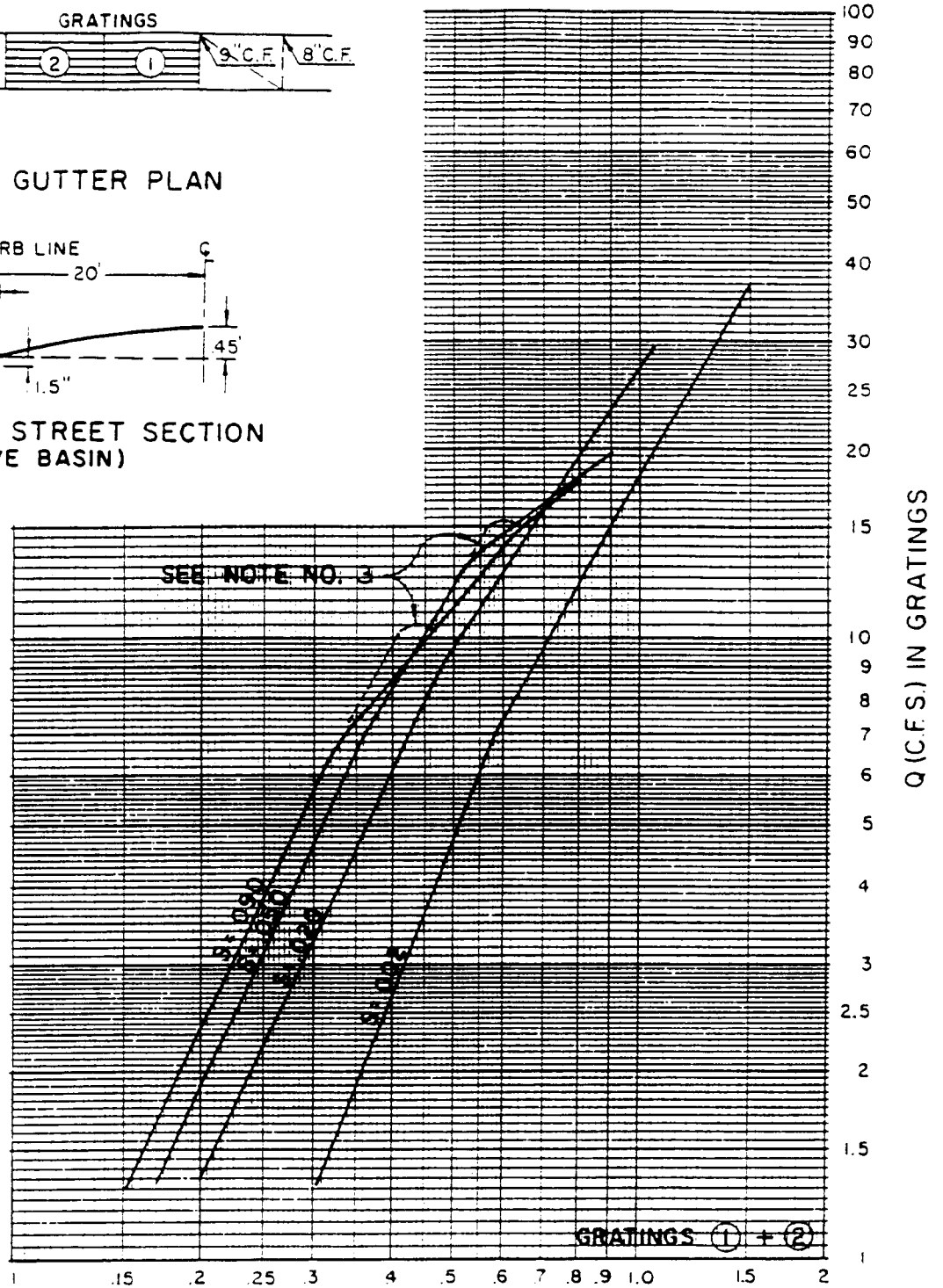

D = DEPTH OF FLOW (FT.) ABOVE NORMAL GUTTER GRADE

Los Angeles County Flood Control Distr

GRATING CAPACITIES
To Be Used For C.B. Nos. 4, 5 & 7

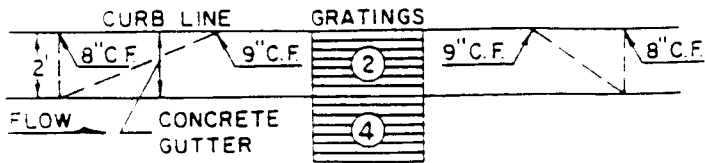

GRATING & GUTTER PLAN

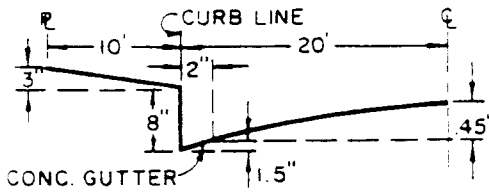

TYPICAL HALF STREET SECTION (ABOVE BASIN)

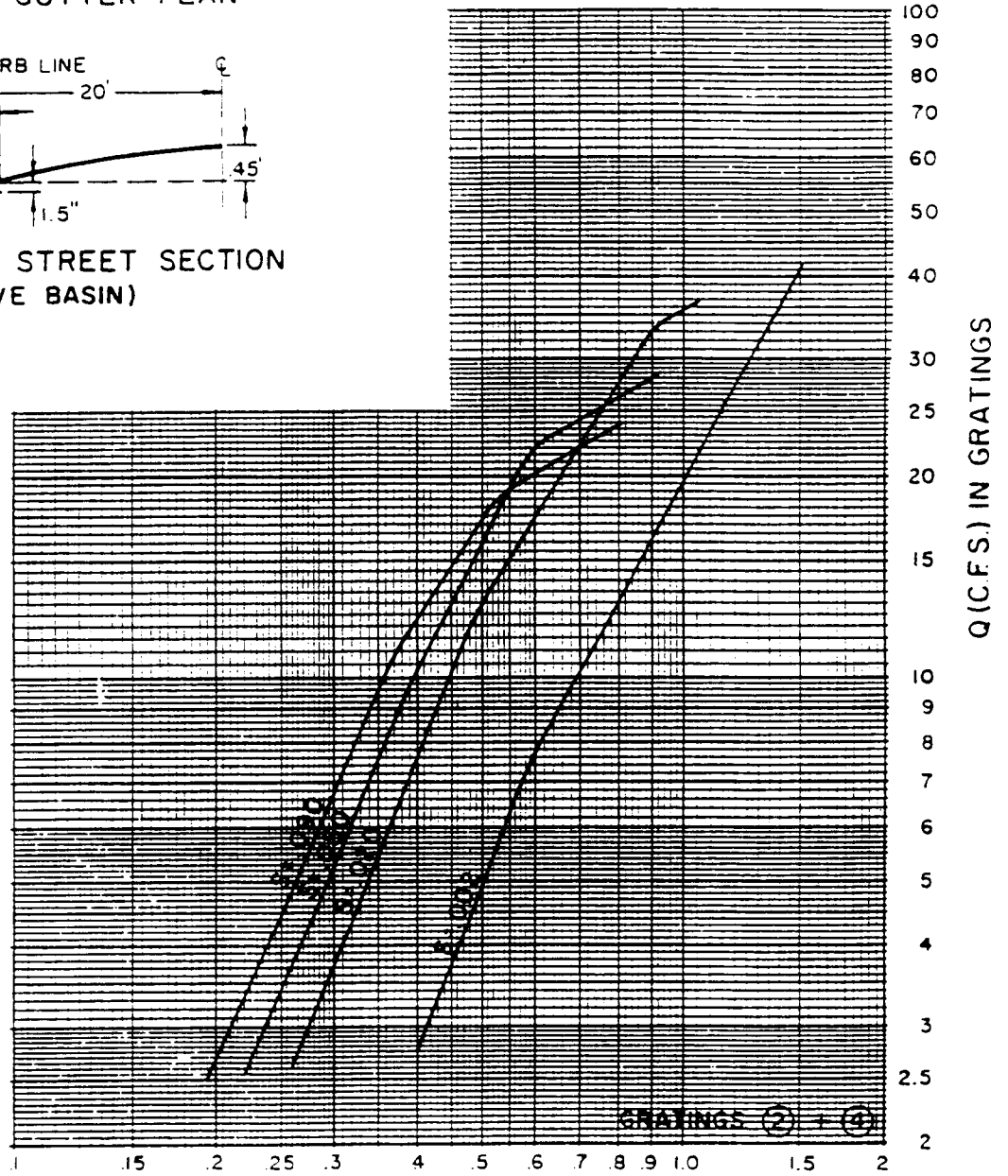

D=DEPTH OF FLOW (FT.) ABOVE NORMAL GUTTER GRADE

Los Angeles County Flood Control District

GRATING CAPACITIES
To Be Used For C.B. Nos. 4, 5 & 7

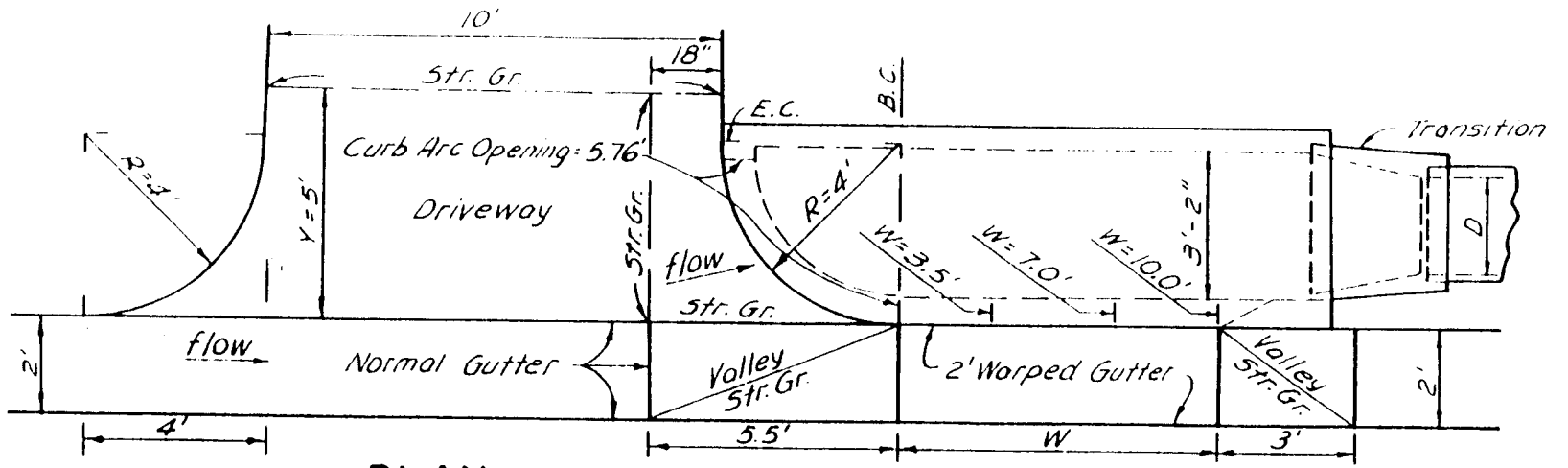

PLAN

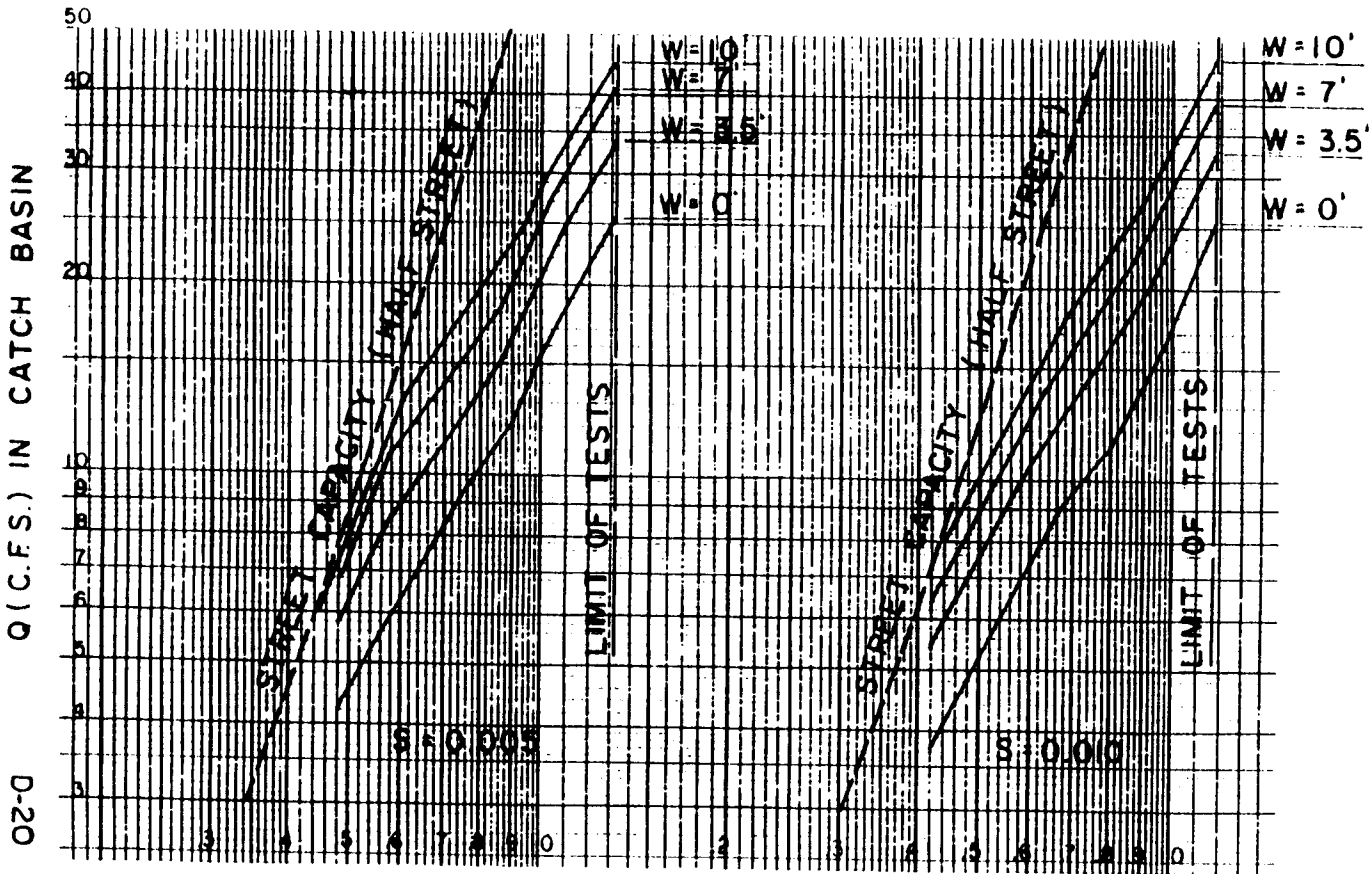

Los Angeles County Flood Control District

CATCH BASIN CAPACITIES

CURB OPENING DRIVEWAY TYPE

TO BE USED FOR C. B. NO. 8

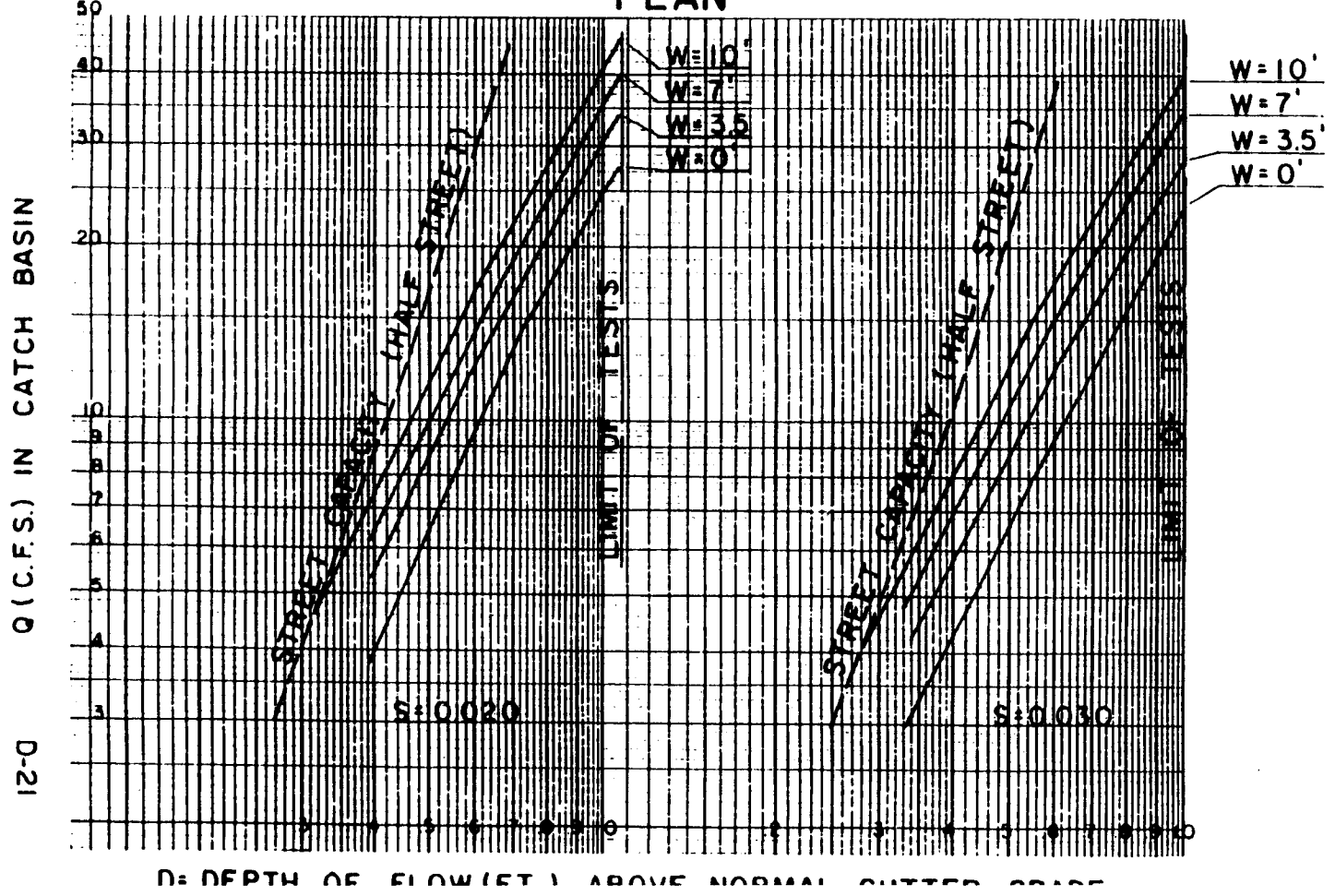
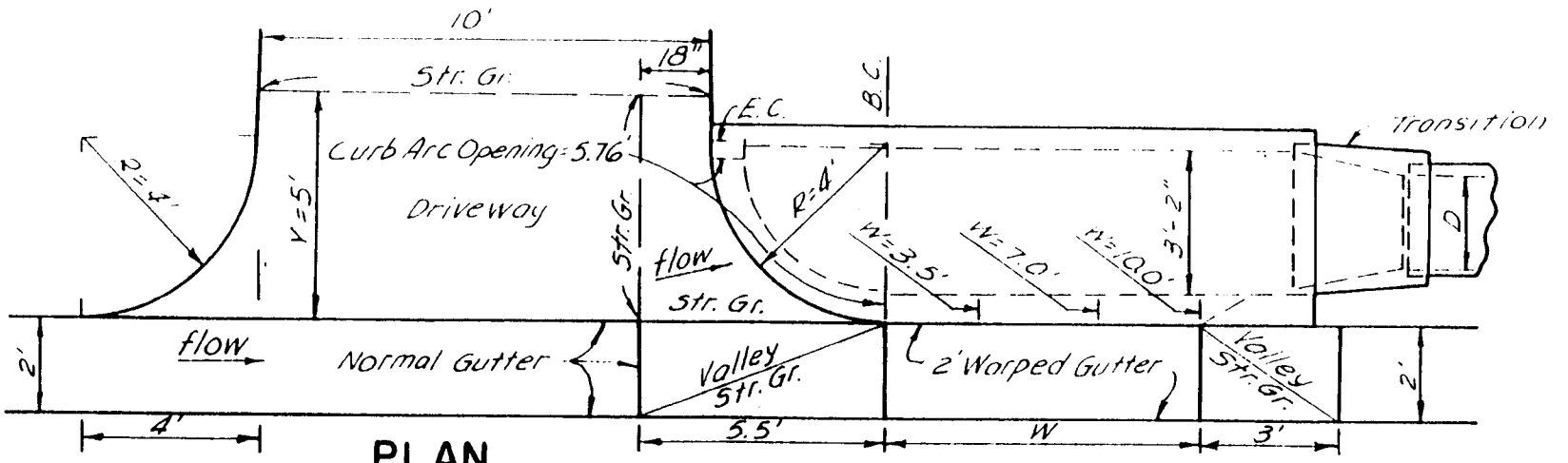

CATCH BASIN CAPACITIES
 CURB OPENING DRIVEWAY TYPE
 TO BE USED FOR C. B. NO. 8

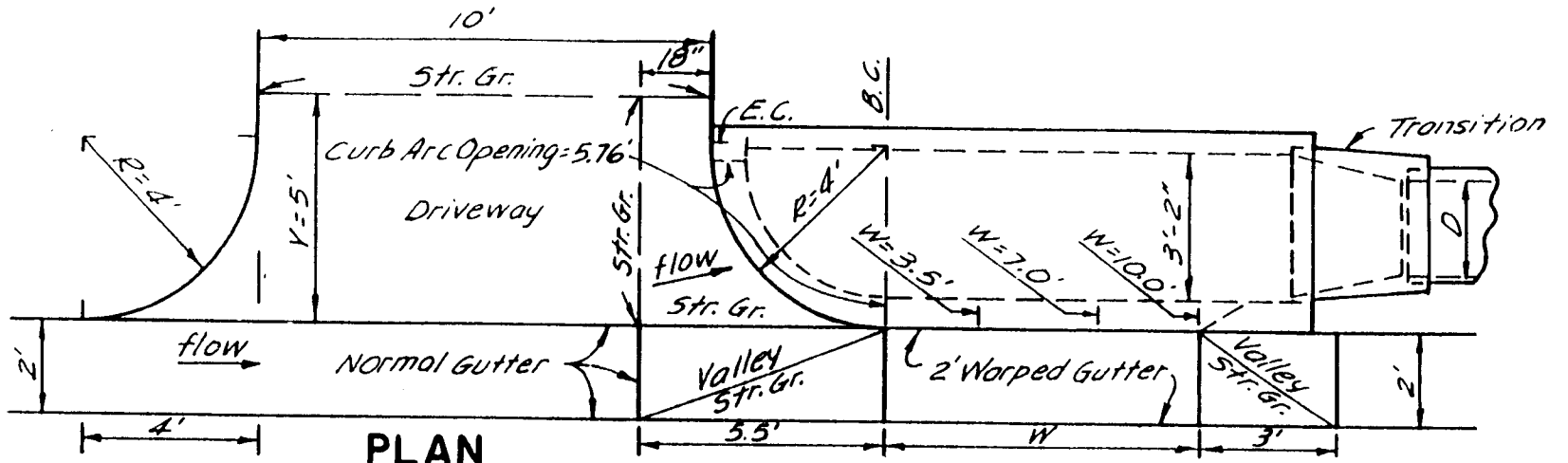

PLAN

D-22 O (C.F.S.) IN CATCH BASIN

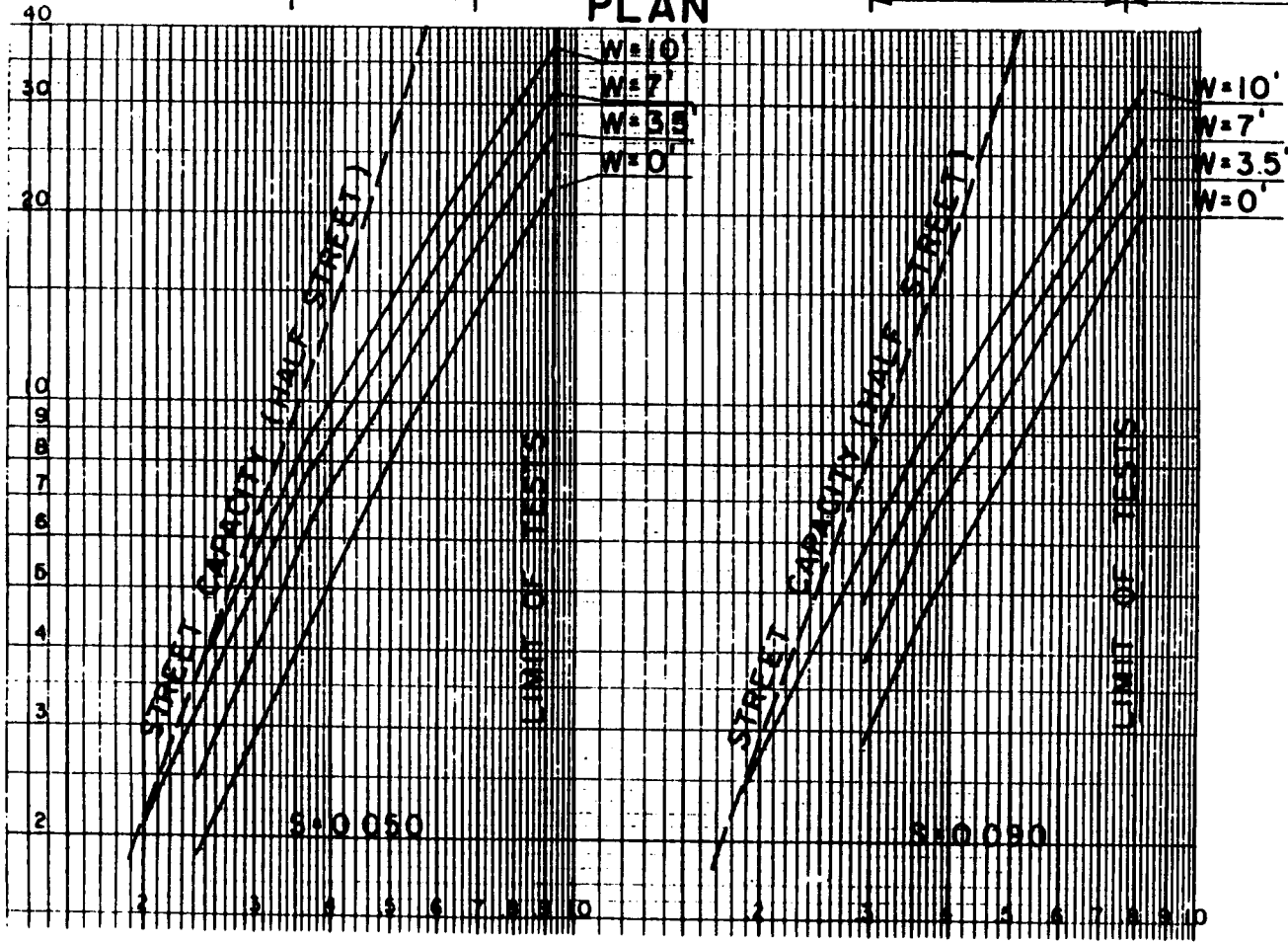

CATCH BASIN CAPACITIES
CURB OPENING DRIVEWAY TYPE
TO BE USED FOR C. B. NO. 8

SUMP FORMULA

$Q = 4.3AD^{0.6}$ (COMPLETE SUBMERGENCE)

A = AREA OF OPENING (W x 0.656).

W = LENGTH (FEET) OF CATCH BASIN
OPENING

D = DEPTH (FEET) OF FLOW ABOVE
NORMAL GUTTER GRADE

8" NORMAL C.F., 9" C.F. AT C.B.

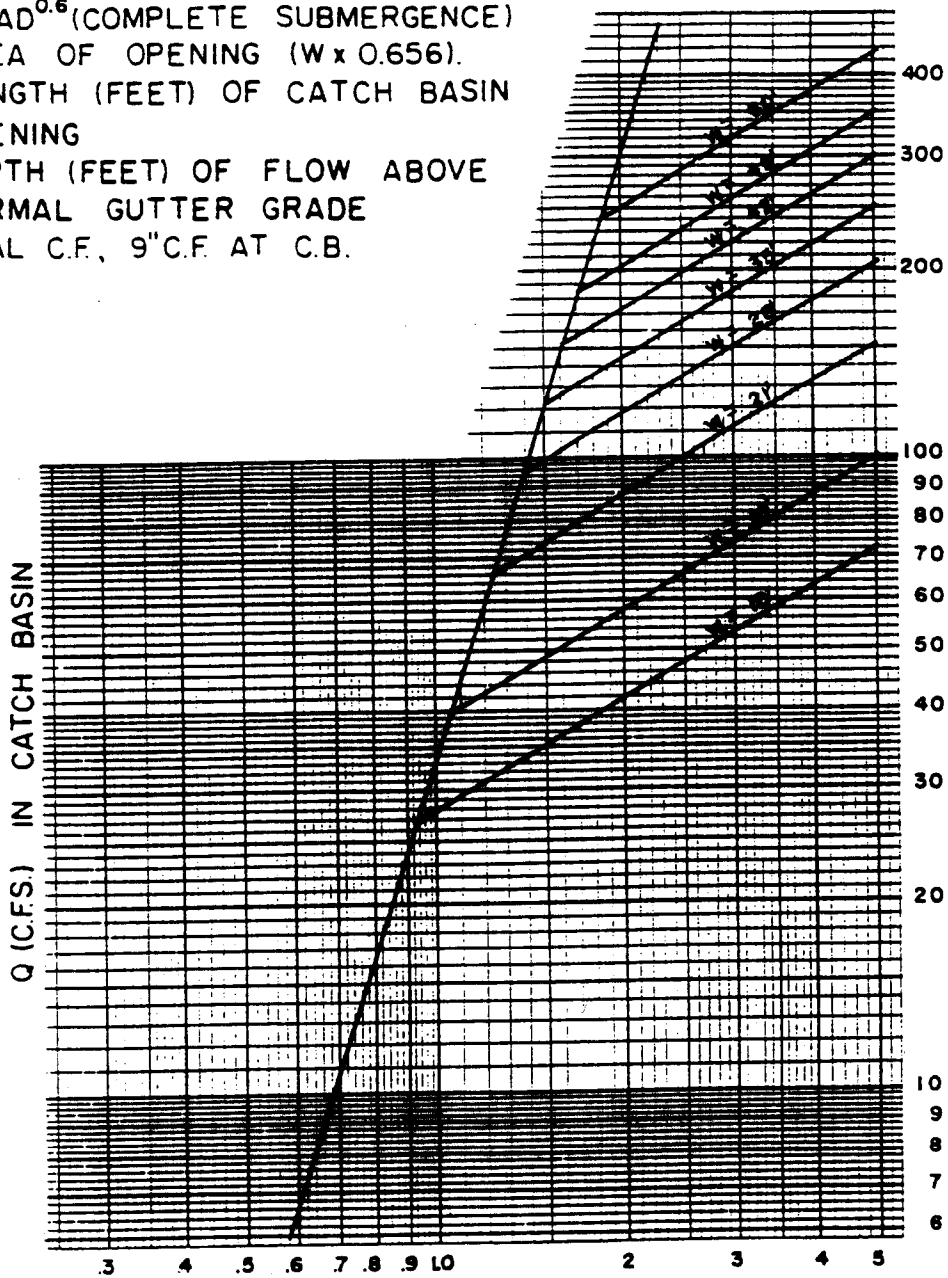

D = DEPTH OF FLOW (FT.) ABOVE NORMAL GUTTER GRADE

Los Angeles County Flood Control District

**CATCH BASIN CAPACITIES
FOR SUMP CONDITION
TO BE USED FOR C.B. NOS. 1, 2 & 3**

**DESIGN OF SPUN CONCRETE
CONNECTOR PIPES FLOWING FULL**

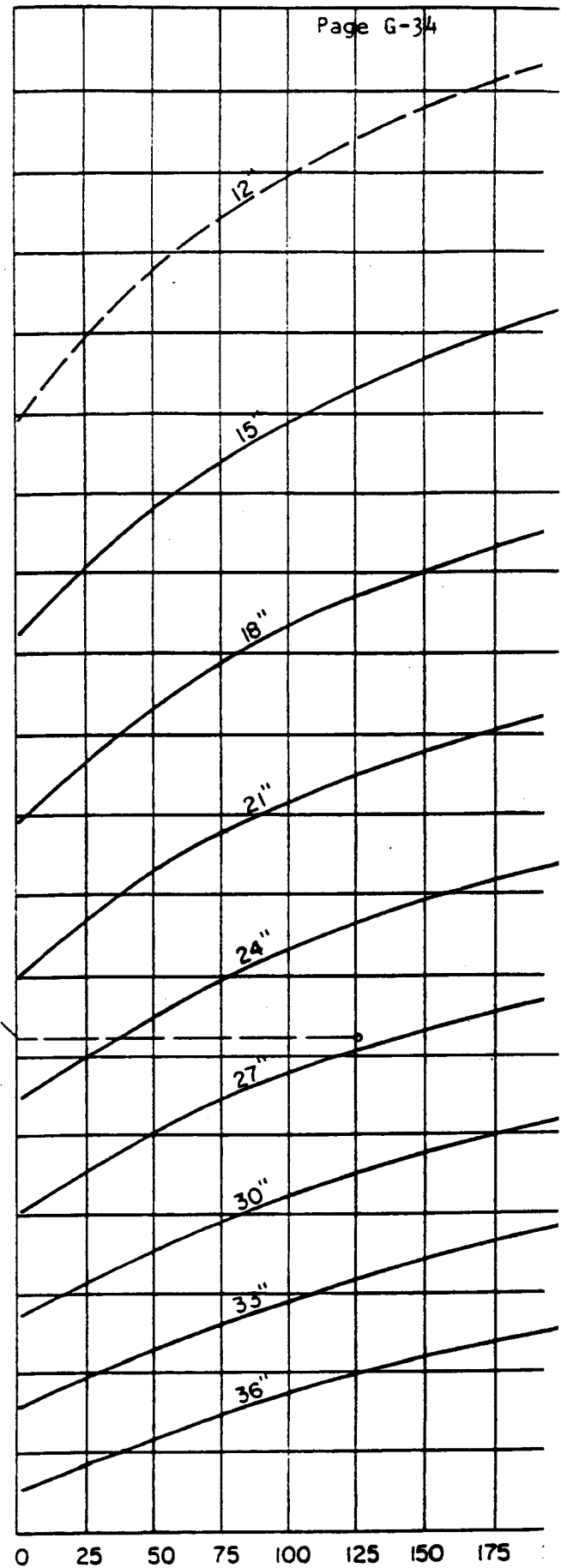
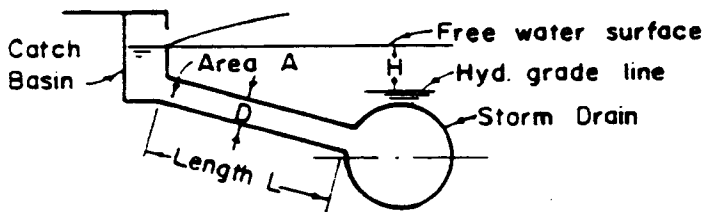
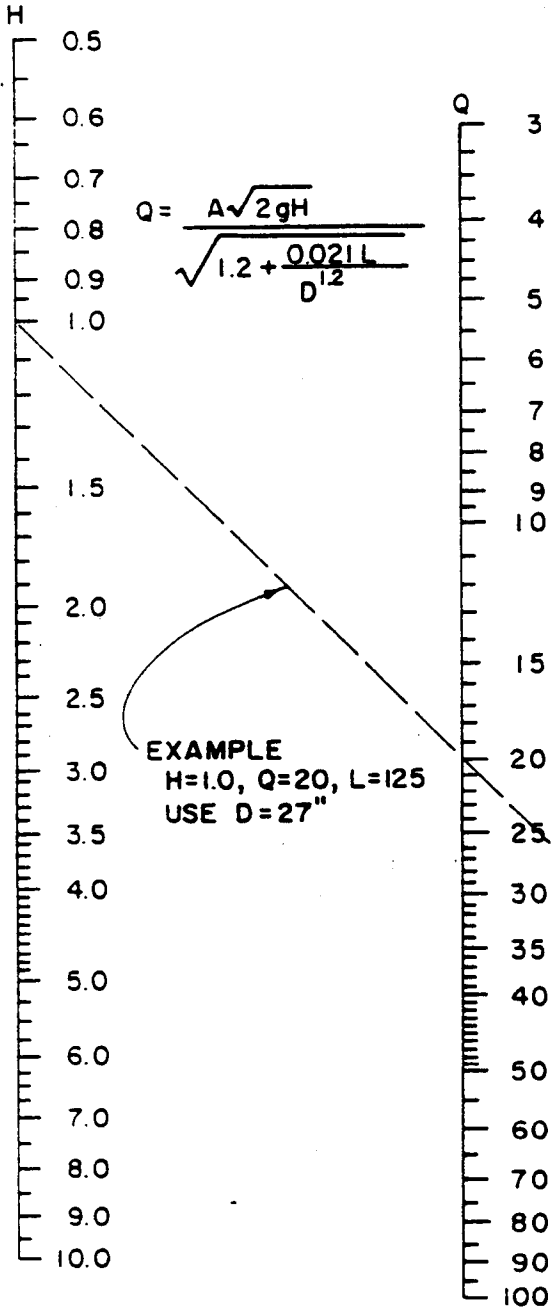

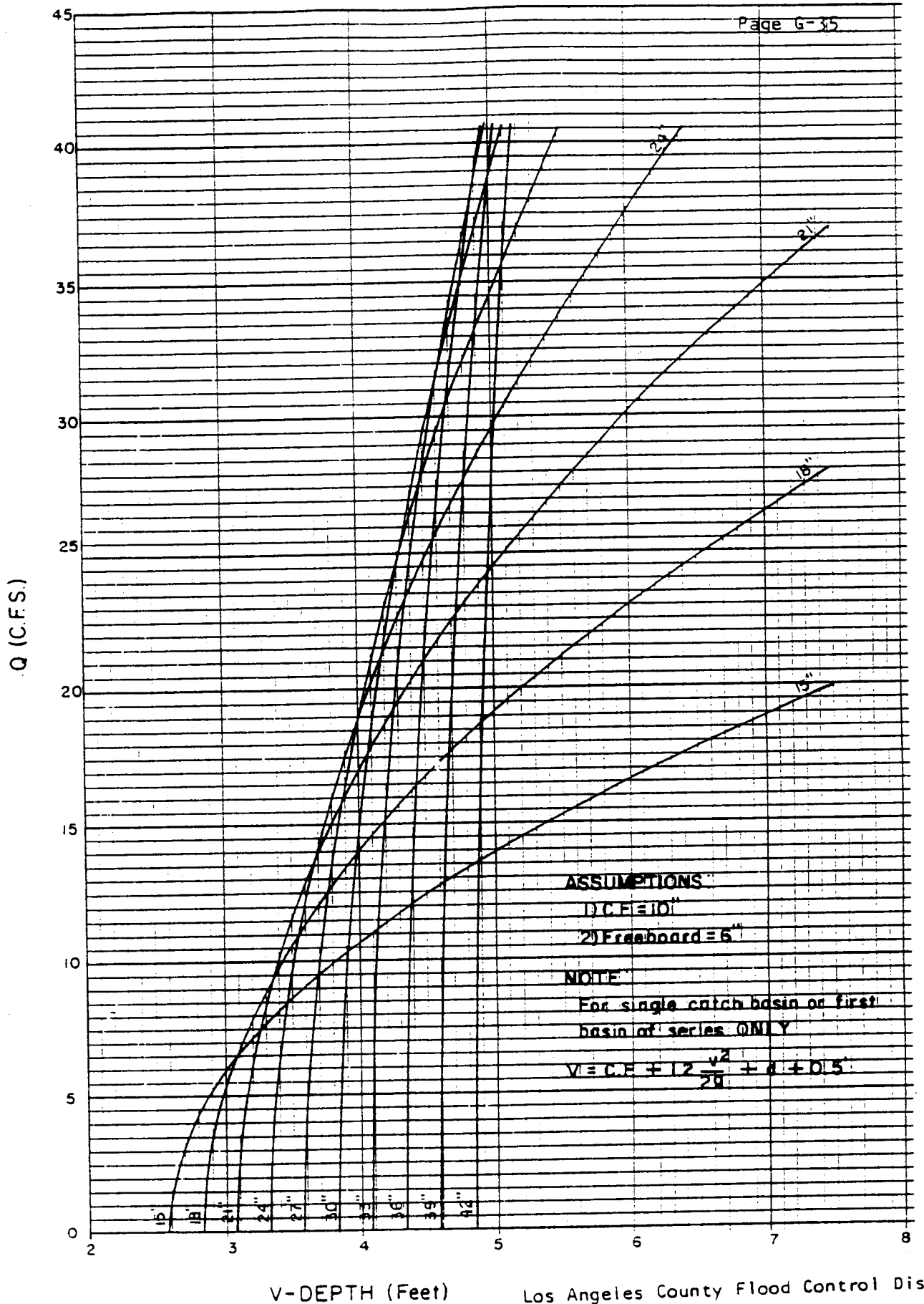

V-DEPTH (Feet)

Los Angeles County Flood Control Distr

CATCH BASIN V-DEPTH

V-DEPTH CHART

Catch Basin Calculation Sheet

PROJECT _____

CALCULATED BY _____

DESIGN FREQUENCY _____

DATE _____

FLOW DIAGRAM (Indicate street slopes)	Sym.	Drain Area	Q		Cap. of $\frac{1}{2}$ Street	Gutter "d"	C. B.		Connector Pipe			V Depth
			Total	Inter.			No.	Size	Head	L	Dia.	

PARTIALLY FILLED CIRCULAR CONDUIT SECTIONS

$\frac{D}{d}$	$\frac{\text{area}}{d^2}$	$\frac{\text{wet. per.}}{d}$	$\frac{\text{hyd. rad.}}{d}$	$\frac{D}{d}$	$\frac{\text{area}}{d^2}$	$\frac{\text{wet. per.}}{d}$	$\frac{\text{hyd. rad.}}{d}$
0.01	0.0013	0.0003	0.0066	0.51	0.4087	1.5703	0.2531
0.02	0.0037	0.0033	0.0132	0.52	0.4227	1.6103	0.2567
0.03	0.0067	0.0062	0.0197	0.53	0.4327	1.6303	0.2591
0.04	0.0105	0.0097	0.0262	0.54	0.4387	1.6503	0.2620
0.05	0.0147	0.0110	0.0326	0.55	0.4426	1.6710	0.2649
0.06	0.0192	0.0147	0.0389	0.56	0.4526	1.6711	0.2676
0.07	0.0242	0.0155	0.0451	0.57	0.4623	1.7113	0.2703
0.08	0.0294	0.0135	0.0513	0.58	0.4723	1.7315	0.2723
0.09	0.0350	0.0094	0.0574	0.59	0.4822	1.7513	0.2753
0.10	0.0409	0.0235	0.0635	0.60	0.4920	1.7722	0.2773
0.11	0.0470	0.0761	0.0695	0.61	0.5013	1.7926	0.2797
0.12	0.0534	0.7075	0.0754	0.62	0.5115	1.8132	0.2813
0.13	0.0600	0.7377	0.0813	0.63	0.5212	1.8333	0.2839
0.14	0.0663	0.7670	0.0871	0.64	0.5303	1.8540	0.2860
0.15	0.0732	0.7954	0.0929	0.65	0.5404	1.8755	0.2881
0.16	0.0811	0.8230	0.0986	0.66	0.5497	1.8965	0.2899
0.17	0.0885	0.8500	0.1042	0.67	0.5594	1.9177	0.2917
0.18	0.0961	0.8763	0.1097	0.68	0.5687	1.9381	0.2935
0.19	0.1039	0.9020	0.1152	0.69	0.5780	1.9590	0.2950
0.20	0.1113	0.9275	0.1206	0.70	0.5872	1.9823	0.2962
0.21	0.1190	0.9521	0.1259	0.71	0.5964	2.0042	0.2973
0.22	0.1231	0.9764	0.1312	0.72	0.6054	2.0264	0.2984
0.23	0.1365	1.0003	0.1364	0.73	0.6143	2.0433	0.2995
0.24	0.1440	1.0237	0.1416	0.74	0.6231	2.0714	0.3006
0.25	0.1535	1.0472	0.1466	0.75	0.6317	2.0844	0.3017
0.26	0.1623	1.0701	0.1516	0.76	0.6404	2.1176	0.3025
0.27	0.1711	1.0923	0.1566	0.77	0.6487	2.1412	0.3032
0.28	0.1800	1.1152	0.1614	0.78	0.6573	2.1652	0.3037
0.29	0.1890	1.1373	0.1662	0.79	0.6655	2.1895	0.3040
0.30	0.1982	1.1593	0.1707	0.80	0.6736	2.2143	0.3042
0.31	0.2074	1.1810	0.1755	0.81	0.6815	2.2395	0.3044
0.32	0.2167	1.2025	0.1801	0.82	0.6893	2.2653	0.3043
0.33	0.2260	1.2237	0.1848	0.83	0.6967	2.2916	0.3041
0.34	0.2355	1.2451	0.1891	0.84	0.7043	2.3186	0.3033
0.35	0.2450	1.2661	0.1935	0.85	0.7115	2.3462	0.3033
0.36	0.2546	1.2870	0.1978	0.86	0.7186	2.3746	0.3026
0.37	0.2642	1.3073	0.2020	0.87	0.7254	2.4033	0.3017
0.38	0.2739	1.3284	0.2061	0.88	0.7320	2.4321	0.3003
0.39	0.2836	1.3470	0.2102	0.89	0.7384	2.4655	0.2986
0.40	0.2934	1.3694	0.2142	0.90	0.7445	2.4731	0.2980
0.41	0.3032	1.3893	0.2181	0.91	0.7504	2.5322	0.2963
0.42	0.3130	1.4101	0.2220	0.92	0.7560	2.5631	0.2944
0.43	0.3227	1.4303	0.2257	0.93	0.7612	2.6061	0.2922
0.44	0.3323	1.4505	0.2294	0.94	0.7662	2.6467	0.2896
0.45	0.3423	1.4706	0.2331	0.95	0.7707	2.6706	0.2864
0.46	0.3527	1.4907	0.2366	0.96	0.7749	2.7339	0.2830
0.47	0.3627	1.5108	0.2400	0.97	0.7785	2.7834	0.2787
0.48	0.3727	1.5303	0.2434	0.98	0.7816	2.8573	0.2735
0.49	0.3827	1.5502	0.2467	0.99	0.7841	2.9212	0.2665
0.50	0.3927	1.5703	0.2500	1.00	0.7854	2.1416	0.2500

Los Angeles County Flood Control District

FACTORS FOR CIRCULAR CONDUITS FLOWING PARTLY FULL

D = depth of water
d = diameter of conduit

Tabulated Values

K = momentum
(C/d)²

C = Pressure
d³

F = Velocity Head
(Q/d²)²

D/d	K	C	F	D/d	K	C	F	D/d	K	C	F	D/d	K	C	F
.00	∞	.0000	∞	.25	.2026	.0157	0.659	.50	.0792	.0833	.1007	.75	.0492	.2121	.0389
.01	23.919	.0000	9188.	.26	.1916	.0173	0.589	.51	.0773	.0873	.0958	.76	.0485	.2185	.0379
.02	8.403	.0000	1134.	.27	.1817	.0190	0.530	.52	.0753	.0914	.0912	.77	.0479	.2249	.0369
.03	4.507	.0001	326.	.28	.1727	.0207	0.479	.53	.0736	.0956	.0869	.78	.0473	.2314	.0359
.04	2.961	.0002	140.9	.29	.1645	.0226	0.435	.54	.0719	.0998	.0829	.79	.0467	.2380	.0351
.05	2.115	.0003	71.9	.30	.1569	.0255	0.395	.55	.0703	.1042	.0793	.80	.0462	.2447	.0342
.06	1.620	.0005	42.1	.31	.1493	.0266	0.361	.56	.0687	.1087	.0758	.81	.0456	.2515	.0334
.07	1.285	.0007	26.5	.32	.1435	.0287	0.331	.57	.0672	.1133	.0726	.82	.0451	.2584	.0327
.08	1.058	.0010	17.97	.33	.1376	.0309	0.304	.58	.0658	.1179	.0696	.83	.0446	.2653	.0320
.09	0.888	.0013	12.68	.34	.1320	.0332	0.280	.59	.0645	.1227	.0668	.84	.0441	.2723	.0313
.10	0.760	.0017	9.28	.35	.1269	.0356	0.259	.60	.0632	.1276	.0641	.85	.0437	.2794	.0307
.11	0.662	.0021	7.03	.36	.1221	.0381	0.240	.61	.0620	.1326	.0617	.86	.0433	.2865	.0301
.12	0.582	.0026	5.45	.37	.1177	.0407	0.222	.62	.0608	.1376	.0594	.87	.0429	.2938	.0295
.13	0.518	.0032	4.31	.38	.1135	.0434	0.207	.63	.0597	.1428	.0572	.88	.0425	.3011	.0290
.14	0.466	.0038	3.48	.39	.1096	.0462	.1931	.64	.0586	.1481	.0551	.89	.0421	.3084	.0285
.15	0.421	.0045	2.84	.40	.1060	.0491	.1804	.65	.0575	.1534	.0532	.90	.0418	.3158	.0280
.16	0.383	.0053	2.36	.41	.1026	.0520	.1689	.66	.0565	.1589	.0514	.91	.0414	.3233	.0276
.17	0.351	.0061	1.982	.42	.0993	.0551	.1585	.67	.0559	.1644	.0496	.92	.0411	.3308	.0272
.18	0.324	.0070	1.681	.43	.0963	.0583	.1489	.68	.0547	.1700	.0480	.93	.0408	.3384	.0266
.19	0.299	.0080	1.438	.44	.0934	.0616	.1402	.69	.0538	.1758	.0465	.94	.0406	.3460	.0265
.20	0.278	.0091	1.242	.45	.0907	.0650	.1321	.70	.0530	.1816	.0450	.95	.0403	.3537	.0261
.21	0.259	.0103	1.080	.46	.0882	.0684	.1248	.71	.0521	.1875	.0437	.96	.0401	.3615	.0259
.22	0.243	.0115	0.946	.47	.0857	.0720	.1180	.72	.0514	.1935	.0424	.97	.0399	.3692	.0256
.23	0.228	.0128	0.833	.48	.0834	.0757	.1118	.73	.0506	.1996	.0411	.98	.0398	.3770	.0254
.24	0.215	.0143	0.740	.49	.0813	.0795	.1060	.74	.0499	.2058	.0400	.99	.0397	.3848	.0253
												1.00	.0396	.3927	.0252

VALUES OF MANNING'S n

PIPE	n	$\frac{2gn^2}{2.21}$
<i>Reinforced Concrete Pipe</i>	.013	.00492
<i>Asbestos Cement Pipe</i>	.013	.00492
<i>Concrete Lined Steel Pipe</i>	.013	.00492
<i>No-joint cast in place Concrete Pipe</i>	.014	.00571
<i>Corrugated Metal Pipe</i>	* varies	
COVERED SECTIONS		
<i>Reinforced Concrete Box</i>	.013	.00492
<i>Reinforced Concrete Arch</i>	.013	.00492
LINED CHANNELS		
<i>Poured Concrete</i>	.014	.00571
<i>Asphalt</i>	.014	.00571
<i>Gunite</i>	.016	.00746
<i>Flush Grouted Cobble</i>	.020	.01166
<i>Medium Weight Levee Riprap</i>	.035	.03570
<i>Jetty Type Riprap</i>	.050	.07285
UNLINED CHANNELS		
<i>Very fine sand, silt or loam</i>	.020	.01166
<i>Usual river sand and gravel</i>	.025	.01821
<i>Coarse gravels</i>	.030	.02623
<i>Coarse gravels mixed with boulders</i>	.035	.03570
REVETTED TRAPEZOIDAL CHANNELS		
<i>Pipe and Wire</i>	.025	.01821
<i>Rail and Wire</i>	.025	.01821

* Refer to Chart F-05

Los Angeles County Flood Control District

VALUES FOR MANNING'S "n" FOR
CORRUGATED STEEL PIPE

SIZE	INVERT - NOT PAVED			HELICAL CORRUGATIONS	INVERT - PAVED (see chart F-06)		
	ANNULAR CORRUGATIONS				ANNULAR AND HELICAL CORRUGATIONS		
	2 2/3"x 1/2"	3"x 1"	6"x 2" Struc. Plate		2 2/3"x 1/2"	3"x 1"	6"x 2" Struc. Plate
12	.026			.016			
18	.026			.016			
24	.025			.019	.023		
30	.025			.020	.023		
36	.025			.021	.023		
42	.025			.022	.023		
48	.025			.023	.023	.025	
54	.024	.027		.023	.022	.025	
60	.024	.027		.023	.022	.025	
66	.024	.027		.023	.022	.025	
72	.024	.027	.033	.024	.022	.025	.030
78	.024	.027	.033	.024	.022	.025	.030
84	.024	.027	.033	.024	.022	.025	.030
90	.024	.027	.033	.024	.022	.025	.030
96	.024	.027	.032		.022	.025	.030
120		.027	.032			.025	.029
132			.032				.029
138 & 7			.031				

- Notes:
1. n values are good for coated and uncoated pipe.
 2. n values for helical corrugations without a paved invert are for the following conditions: (a) pipe flowing full, (b) very minor debris flow, (c) relatively straight alignment.
 3. For Arch sections use values for annular corrugations and a equivalent diameter for the Arch section. $D=4R$, R=hydraulic radius of arch section.
 4. There is a slight decrease in the interior area which should be considered when calculating the conveyance factors on pipes with paved inverts.

(2/3)

Conveyance Factor $K=1.486 AR$ (A=interior area of conduit, R=hydraulic radius of conduit, n=Manning's n)

Los Angeles County Flood Control District

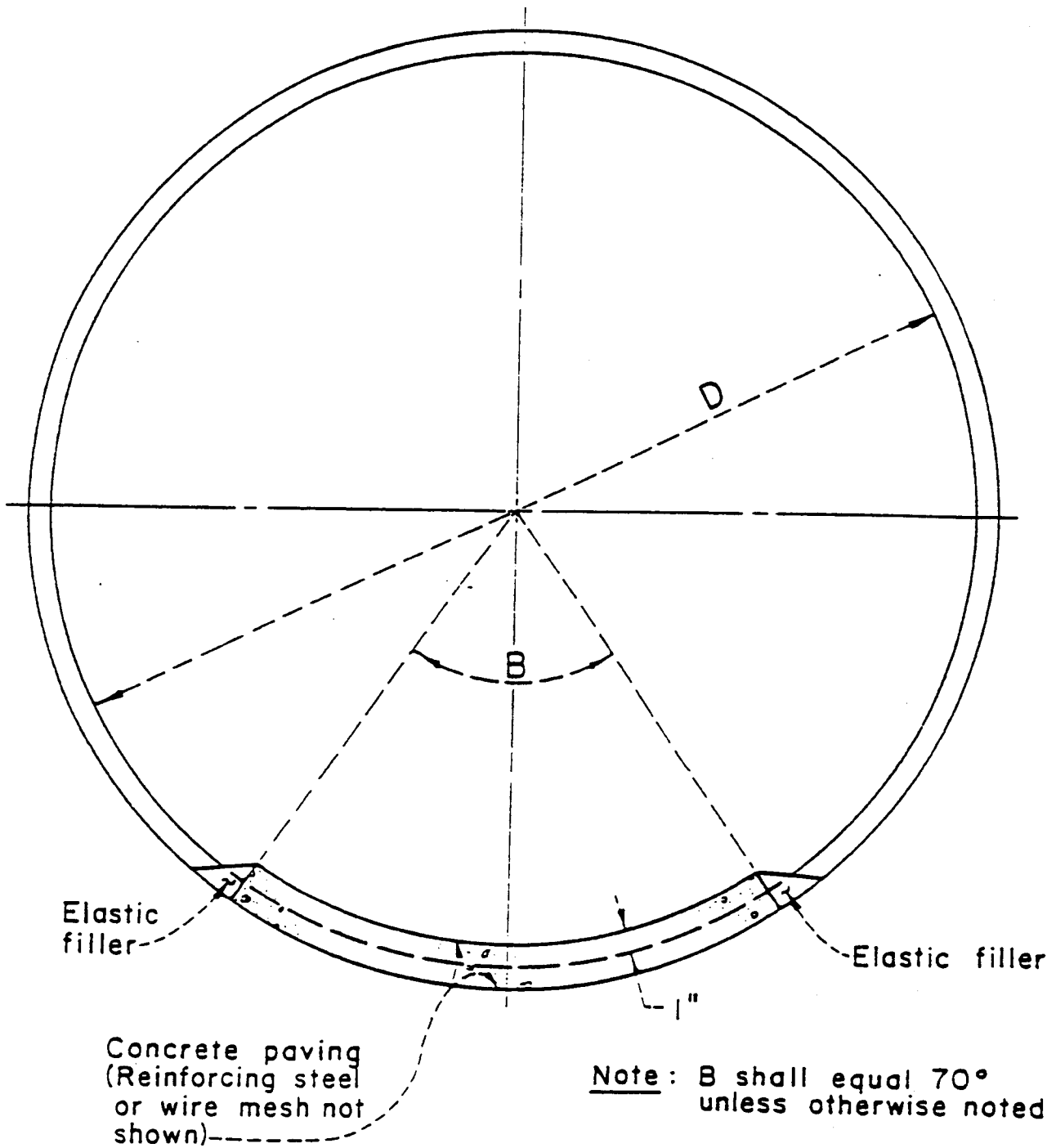

CORRUGATED STEEL PIPE WITH PAVED INVERT

INDEX

HYDRAULIC DESIGN MANUAL

	<u>Page</u>
A	
Angle Point Loss -----	B-8
B	
"b" Dimension -----	D-8
Beach Outlet -----	B-12
Bend Loss -----	B-7
Bernoulli Equation -----	B-3
Branching Flows, Loss -----	B-9
Bridge Piers -----	C-7
C	
Calculations, Direction of -----	C-3
Calculations, Water Surface Profile -----	B-1, C-1
Catch Basin Data and Calculations -----	D-2
Catch Basin Design Q -----	D-1
Catch Basin, Driveway -----	D-8
Catch Basin, Grating Type -----	D-7
Catch Basin Length -----	D-8
Catch Basin Right of Way -----	D-6
Catch Basin, Series -----	D-4, D-2
Catch Basin, Side Opening -----	D-2
Catch Basin Subareas -----	D-1
Catch Basin, Sweeper -----	D-3
Channel Stabilizers -----	C-17
Composite Linings, Mannings on -----	C-16
Computer Program -----	B-4
Confluence Angle -----	B-14
Confluence Loss, See Junction Loss -----	
Connector Pipe -----	D-2, D-9
Control Points -----	B-1, B-2, C-2, C-3
Convergent Walls (Open Channel Transitions) -----	C-6
Corrugated Steel Pipe -----	B-15
Criteria, General Hydraulic -----	B-1, B-1
Criteria, General Hydrology -----	A-1
Critical Depth -----	C-1, C-2, C-3
Cutoff Points -----	D-7
Curving Alignments, Open Channels -----	C-10

Index - continued.

	<u>Page</u>
J	
Junction Analysis -----	E-6 to E-15
Junction Loss -----	E-6, C-4
L	
Length of Easement Curves -----	C-14
Local Depressions -----	E-7, D-9
Loss, Angle Point -----	E-8
Loss, Bend -----	E-7
Loss, Branching Flows -----	E-9
Loss, Flow Split -----	E-9
Loss, Friction -----	E-4, C-3
Loss, Junction -----	E-6, C-4
Loss, Manhole -----	E-7
Loss, Transition -----	E-5
Loss, Trashrack -----	E-2
Levee Criteria -----	F-29, F-37
M	
Maintenance and Access Design Requirements -----	E-9
Manhole, Deep -----	E-11
Manhole Design -----	E-10
Manhole Location -----	E-10
Manhole Loss -----	E-7
Manhole, Pressure -----	E-11
Manhole Spacing -----	E-9
Manhole, Special -----	E-11
Manning Equation -----	E-4, C-3
Maximum Sidewall Slope for Trapezoidal Channel -----	C-16
Minimum Pipe Size -----	E-11
Minimum Slope -----	E-12
"Must", Catch Basins -----	D-6
N	
n, Manning Values -----	G-39, G-40
O	
Open Channels, General Criteria -----	C-1
Outlet Structure -----	E-12

Index - continued.	<u>Page</u>
Trapezoidal Channel, Maximum Sidewall Slope -----	C-16
Trashrack Head Loss -----	F-2
Tunnel, Minimum Size -----	E-11

U

Unlined Channel -----	C-17
-----------------------	------

V

"V" Depth Calculations -----	D-2
Velocity, Maximum in Unlined Channel -----	C-17

W

Water Surface Controls -----	E-1, C-2
Water Surface Profile Calculations -----	E-1, C-1
Water Surface Profile Calculations Example Problem -----	E-16